

Truma Combination Boiler	94
Truma heating system and air flow	95
Truma CP 25 digital timer control	95
Truma CP Plus digital timer control	99
Truma Combination Boiler fault finding	107
Truma Combi heating system function description	108
ALDE Compact 3010	112
ALDE Compact 3010 Control Panel	117
Thetford refrigerators	125
Dometic absorption refrigerators	133
Cooker 3 burner and hotplate	154
Cooker 3 burner gas hob (Sprite only)	159
Microwave oven	162
Thetford C260 cassette toilet	165
Caravans with external BBQ point	172
Caravans with TV inlet in battery box	173
Status 550 directional TV and FM radio antenna	175
Bedding	176
Softrollo Blinds (Seitz)	177
Doorscreen	177
Roof lights	178
Exterior Door Key	178
Windows	178
Heki-2 roof light (Seitz)	179
Mini Heki rooflight	179
Care of laminate tops, tables, furniture and doors	179
Doors	179
Tables	180
Table storage	180
12V reading lamp	180
Trigger shower heads	180
Fixing of awnings	180
Paint colour reference.....	181
Drop down TV mechanism	181
Front locker and sunroof.....	181
Bonded Roof.....	181
Step on hitch cover	181
Cycle racks	182
Caravan motor mover.....	182
Omni-vent	183
Rear view camera.....	185

TRUMA COMBI BOILER

The instructions covering fitted equipment to your caravan were correct at the time of going to print. Owners handbooks are updated annually and we take great care to try and ensure their accuracy. However, the Swift Group Limited cannot accept responsibility for any changes that may be made in specification or operating instructions to the equipment described in this section after the time of going to press.

Every care is taken to ensure that the information provided in this handbook is correct and easy to understand.

Separate manufacturers' leaflets on many of the components are also included in the Owner's Pack provided with this caravan and we recommend that you compare the instructions in the handbook with the component manufacturers literature, to ensure the information provided is as accurate as possible.

If you are in any doubt as to how to operate the equipment in your caravan, please contact the component manufacturer's service department on the telephone number shown on their component leaflet. If you remain in any doubt, please contact your supplying dealer.

Notice: In the interest of safety, replacement parts for an appliance shall conform to the appliance manufacturer's specifications and should be fitted by them or their authorised agents.

Truma Combination Boiler

The Truma Combination boiler has been designed to run on gas or electric power and the optimum performance is obtained when used in **dual fuel mode, that is running on gas and electric at the same time.**

Running in dual mode has the following benefits:

- Fastest possible heat up time, the gas burner combines with an electric element to provide energy to heat your hot water and warm your caravan.
- The intelligent heat management system automatically senses when the water and room are nearing the required temperature and then automatically turns off your gas burner and operates solely on electric power, conserving your gas.
- As hot water is used or the room cools the Truma combination heater will continue to operate on electric only until a point where the demands necessitate that additional gas power is required. An example for such a demand could be for instance if the exterior door was left open and the room temperature dropped by 10 degrees in the space of a few minutes, in this case the intelligent heat management system would decide the best way to get the room back to the required temperature would be to use both gas and electric at the same time.

Operating the Truma Combination system on electric or gas only will result in longer heat up times for hot water and the room temperature in comparison to operating on dual fuel.

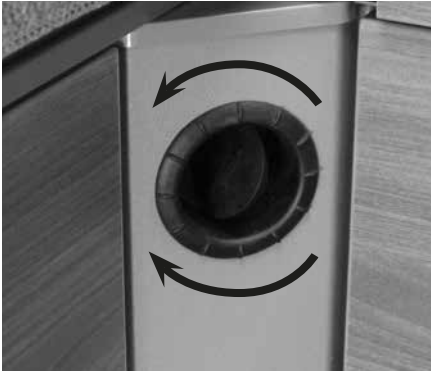
Operating on electric only may not in all cases maintain a comfortable room temperature especially in colder conditions.

The intelligent heat management system in dual fuel mode allows the Truma Combination boiler to prioritize the electric power source over your gas, this will conserve your gas supply.

Truma Heating System and Air Flow

The Swift Group undertakes considerable testing of our products in cold chambers to ensure they meeting the BS EN 1649 Grade 3 standard and are usable in cold temperatures. During this testing, the air flow on the blown air outlets is defined and set by us.

Butterfly outlets



Blown air

The air ducting outlets on some models are of the butterfly type, and if fitted these may be opened or closed by adjusting the butterfly valves. Twisting the disc in its housing directs the flow in the direction required. One outlet on each leg of the air ducting layout must be kept open at all times, and when high specification (Combi 6) heating systems are fitted, depending on the number of blown air outlets in the layout, butterfly fittings may not be present.

Under no circumstances should the air ducting outlets be blocked.

Note: The next instructions detail the operation of the Combi Control Panel - for further details of the Truma Combi appliance, please see the following section.

Truma Heating System Control Panels

Depending on the specification of your caravan, when the Combi heating is fitted, either a CP25 Controller or CP Plus Controller will be fitted.

Truma CP 25 Digital Timer Control

Operating instructions

Depending on the specification of your caravan, the CP25 controller may be fitted to control the operation of the Truma Combi appliance.


Please be sure to read the instructions for installation and use before attempting to connect and use this device!

Symbols used

 Symbol indicates a possible hazard.

Comment including information and tips.

Safety instructions

 To protect you from electrical shocks, injury or burns the following basic safety principles must be observed when using electrical devices. Please read and follow these instructions before using the device.

Installation

Ensure that the devices are positioned safely and cannot fall down or over. Always position the cables to ensure they do not pose a tripping hazard. Do not expose electrical devices to rain. Do not operate electrical devices in damp or wet environments. Do not operate electrical devices close to flammable liquids or gases. Position the devices so that they are out of the reach of children.

Protection against an electrical shock

Only operate devices whose casings and cables are undamaged. Ensure the cables are installed safely. Do not pull on the cables.

TRUMA CP 25 DIGITAL TIMER CONTROL

Use

Do not use electrical devices for purposes other than those stated by the manufacturer.

Repairs

Do not repair or modify the device. Please contact your dealer or the Truma Service (see service manual or www.truma.com).

Accessories

Only use accessories and additional devices that are supplied or recommended by the manufacturer.

Intended use

The CP 25-UK is a digital operating / display and control unit for the Combi Boiler.

The device is designed to be installed in caravans and motorcaravans.

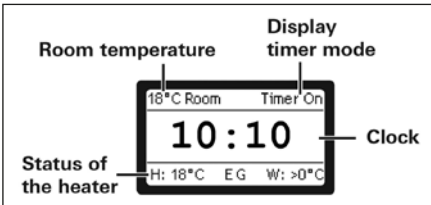
Initial operation or activation after a power cut

After the operating voltage has been connected, the unit will beep and the display remains dark. To switch on, press the key Δ and the main screen will appear.

Function description

Note: More details regarding the operating modes can be found in the operating instructions of your Combi.

Main Screen



Room temperature: Display on when the heater is active

Timer: Display on when the timer is active

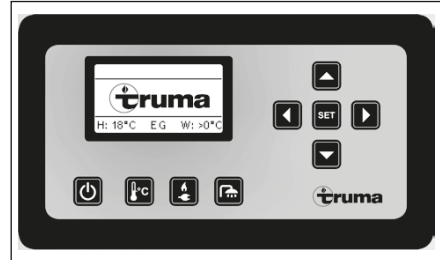
Clock: Only if the clock has been set, otherwise the Truma logo will appear in the display

Status of the heater :

H: Set room temperature (e.g. 18°C)

EG: Energy selection (E = Electro, G = Gas)

W: Set water temperature



- ▲ Selection Key upwards to select functions or set values
- ▼ Selection key downwards to select functions or set values
- ◀ Selection key backwards to select values
- ▶ Selection key forwards to select values

On / Off

- Display and heater is switched on and / or off
- The clock is shown when the time is set
- After an interruption in the operating voltage, the display and the heater are switched off. If the time is shown, this needs to be set.

Green LED shines when the heater is on

Green LED flashes when the heater is after-running

Red LED shines when there is a malfunction

Manual mode

- In manual mode, the heater is controlled via the 4 keys below the display.
- It is not necessary to set the time because the Truma logo is shown in the display instead of the time.

Note: A pre-selection between summer / winter operation must be made via the set-up.

Room Temperature

When the menu is selected the yellow LED shines.

The current set room temperature is displayed and can be changed.

Key ▲ increases the room temperature (max 30°C) by 1°C.

Key ▼ reduces the room temperature (min 5°C) by 1°C.

A change in the room temperature needs to be confirmed with **SET**.

Energy selection

When the menu is selected the yellow LED shines.

Depends on summer / winter operation (see setup)

- Use key ▲ or ▼ to select the energy source and confirm with **SET**.
- Bar shows current mode.

Summer operation

230 V - 4 A (electro mode 230 V, 900 W)

230 V - 8 A (electro mode 230 V, 1800 W)

Gas powered

Winter operation

230 V - 4 A (electro mode 230 V, 900 W)

230 V - 8 A (electro mode 230 V, 1800 W)

Gas powered

230 V - 4 A and gas (mixed operation gas and electro mode 900 W)

230 V - 8 A and gas (mixed operation gas and electro mode 1800 W)

Note: If electro or mixed operations are selected and there is no 230 V power supply, the heating will not function.

Water temperature

When the menu is selected the yellow LED shines. During the heating-up phase, the set water temperature flashes in the main screen.

- Use key ▲ or ▼ to select the water temperature and confirm with **SET**.
- Bar shows current mode

Depends on summer / winter operation (see setup)

Summer operation

Water 40°C

Water 60°C

Winter operation

Water > 0°C (heating **without** controlled water temperature, heating has priority)

Water > 60°C

Timer mode

- The heater runs in timer mode as soon as one or both timers have activated in the setup.
- 'Timer On' appears in the main screen.
- The heater is only active in the set time window (active timer)
- Only the energy selection can be changed in the case of an active timer
- A change in the room or water temperature will automatically switch the control system into manual mode.

Set up

In the main screen display you can enter the setup menu via the setup key.

The following settings can be made:

Back (return to main screen)

Timer 1 on / off (select **SET** on / off)

Timer 2 on / off (select **SET** on / off)

Summer / Winter (select **SET** summer / winter)

TRUMA CP 25 DIGITAL TIMER CONTROL

Set clock

Set timer 1

- Back (Return to main screen)
- Start (Set start time)
- Stop (Set stop time)
- Water (Set water temperature)
- Temp (Set room temperature)

The timer settings can be made every day until the timer is switched off. If the room or water temperature is changed outside the timer menu, the timer is automatically switched off.

Set timer 2

- Back (Return to main screen)
- Start (Set start time)
- Stop (Set stop time)
- Water (Set water temperature)
- Temp (Set room temperature)

The timer setting can be made every day until the timer is switched off. If the room or water temperature is changed outside the timer menu, the timer is automatically switched off.

Buzzer on / off (select **SET** on / off)

Backlight (brightness levels 0-9)

Note: If no action is taken, the display switches back to the main screen after a few seconds. The lighting switches off after a short delay.

Trouble shooting list

Fault	Rectification / Cause
Clock is not shown	Set clock
Activated timer is not shown anymore	Power supply was interrupted
Room temperature is not shown	Heater not active
Device does not react anymore	Interrupt power supply for 10 seconds
Heater / display does not react	Check 12 V supply voltage

If these measures do not rectify the problem, please contact the next Truma service point (See Truma service book or www.truma.com)

Truma CP Plus Digital Timer Control

Depending on the specification of your caravan, the Truma CP-Plus controller may be fitted to control the operation of the Truma Combi appliance.

Safety instructions

- The device may only be operated if it is in perfect working order.
- Arrange for malfunctions to be rectified immediately. Only rectify malfunctions yourself, if the remedy is outlined in the troubleshooting information in these Operating Instructions.
- Do not repair or modify the device!
- Only allow the manufacturer or its customer service to repair a faulty device.

Note: If the power supply to the systems is interrupted for longer than 20 minutes, the time and date need to be entered again.

Important note

If the power supply to the systems is interrupted for longer than 20 minutes, the time and date need to be entered again.

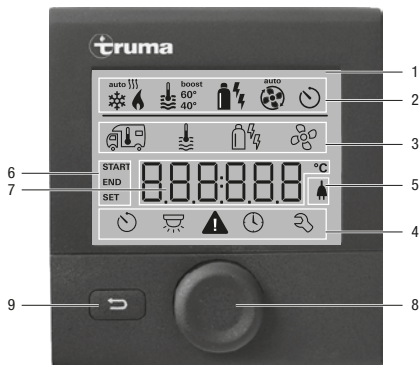
Intended use

The control panel Truma CP plus serves to control and monitor a Combi heater and / or a Truma air conditioning unit. The device is designed for installation in caravans and motor-caravans.

For clarity only the instructions relevant to combi heating are included in this guide. Instructions relevant to air conditioning should be requested if an appropriate air conditioner is fitted.

TRUMA CP PLUS DIGITAL TIMER CONTROL

Display and control elements

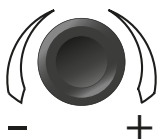


- 1 - Display
- 2 - Status line
- 3 - Menu line (above)
- 4 - Menu line (below)
- 5 - Display of mains voltage 230 V (shore power)
- 6 - Display timer
- 7 - Settings / values
- 8 - Control knob / push button
- 9 - Back button

The control knob / push button (8) is used to select menus in the lines (3 + 4) and configure the settings. These are shown via a display (1) with a lighted background. Pressing the Back button (9) takes the user back out of the menu again.

Control knob / push button

The control knob / push button (8) is used to select and change set values and parameters; these can be saved by clicking the control knob / push button. Selected menu items will flash.



Turn to the right (+)

- Menu is paged from left to right.
- Increase values.

Turn to the left (-)

- Menu is paged from right to left.
- Reduce values.



Clicking

- Accept (save) a selected value.
- Select a menu item, change to the setting level.



Press (3 seconds)

- Main switch function ON / OFF

Back button

Pressing the Back button (9) takes the user back out of the menu again and discards the settings. This means that the previous values are retained.

Functions

The functions in the menu lines (3, 4) of the control panel can be selected in any sequence. The operating parameters are shown in the status line (2) or the displays (5, 6).

Start / stand-by screen

After connecting the control panel to the power supply, a start screen is shown after a few seconds.



If no entry is made within a few minutes, the standby screen is automatically shown again. The display shows the time and current room temperature alternately.

Switch on / return to setting level

- Press the control knob / push button for longer than 3 seconds or the
- Back button.

The display shows the setting level. The first symbol flashes.



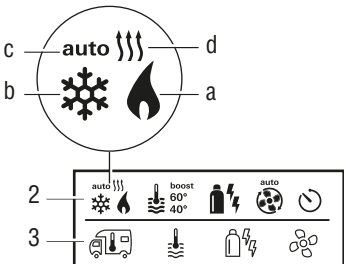
Note: Previously set values / operating parameters become active again after the system is switched on.

Switch off

- Press the control knob / push button for longer than 3 seconds.

Change the room temperature

- Use the control knob / push button to select the symbol in menu line (3).
- Click to change to the setting level.
- Depending on the connected device, use the control knob / push button to select between the heater or air conditioning unit.
- Use the control knob / push button to select the required temperature.
- Click the control knob / push button to confirm the value.



Heater

Settable temperature range 5 - 30 °C (1 °C steps)

a = heater * – Heater is switched on.

Air conditioning unit (not normally fitted)

Settable temperature range 16 - 31 °C (1 °C steps)

b = cool *
(Air conditioning unit is switched on)

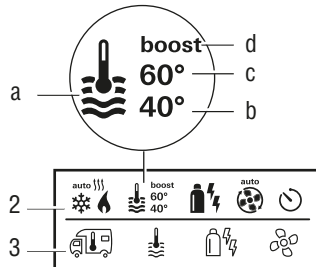
c = auto
(Air conditioning unit is set to automatic)

d = hot
(Air conditioning unit is in heating mod.)

* This symbol will flash until the required room temperature is reached.

Change the warm water level

- Use the control knob / push button to select the symbol in menu line (3).
- Click to change to the setting level.
- Use the control knob / push button to select the required level.
- Click the control knob / push button to confirm the value.



a = Boiler *
(Warm water boiler is switched on)

b = 40°
(Warm water temperature 40 °C)

c = 60°
(Warm water temperature 60 °C)

TRUMA CP PLUS DIGITAL TIMER CONTROL

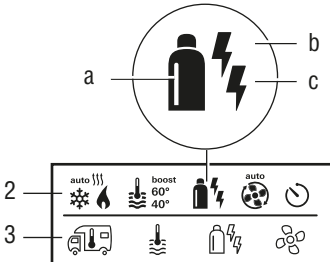
d = boost *

(Targeted, fast heating of the content of the boiler [boiler priority]. The water temperature is kept at the higher level [around 62 °C] – Not Combi Diesel. Once the water temperature is reached, the room is heated again.)

* This symbol will flash until the required water temperature is reached.

Select power type

- Use the control knob / push button to select the symbol in menu line (3).
- Click to change to the setting level.
- Use the control knob / push button to select the required power type.
- Click the control knob / push button to confirm the value.



Symbol	Operating mode	Power type
a	Gas	Gas
b	EL 1	Electro
b + c	EL 2	Electro
a + b	Mix 1*	Gas + Electro
a + b + c	Mix 2*	Gas + Electro

* Mixed mode

Special aspects in the mixed mode

Interruption of the power supply 230 V

Combi Gas

The heater automatically switches to the gas mode. As soon as the 230 V power supply is reconnected, the heater automatically switches

back to the mixed mode.

Malfunction in the combustion process (e.g. lack of fuel)

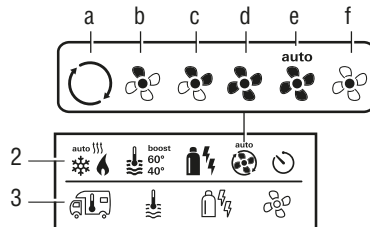
Combi Gas

The heater automatically switches to the electro mode. If the heater should operate in the mixed mode again, the cause of the malfunction needs to be rectified. Switch the heater off and on again on the control panel.

Select fan level

When the heater / air conditioning unit is connected.

- Use the control knob / push button to select the symbol in menu line (3).
- Click to change to the setting level.
- Use the control knob / push button to select the required fan level.
- Click the control knob / push button to confirm the value.



Symbol	Operating mode	Description
–	Off	Fan is switched off
a	Vent	Circulating air, if no device is in operation. 9 speed levels can be selected.
b	Eco	Low fan level
c	Mid	High fan level (only Combi Gas)
d	High	Fast heating of the room. Available, if the difference between the selected and current room temperature is >10 °C.

Set timer

- Use the control knob / push button to select the symbol in menu line (4).
- Click to change to the setting level.

Note: If the timer is activated (ON), the timer in the menu is shown as deactivated (OFF).

Enter start time

- Use the control knob / push button to set the hours, then the minutes.



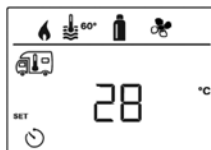
Enter end time point

- Use the control knob / push button to set the hours, then the minutes.

Note: If the start / end times are exceeded when entered, the operating parameters are only taken into consideration when the next start / end times are reached. Until then, the operating parameters set outside the timer remain valid.

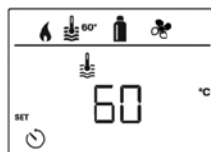
Set the room temperature

- Click to change to the setting level.
- Use the control knob / push button to select the required room temperature.
- Click the control knob / push button to confirm the value.



Set the warm water level

- Click to change to the setting level.
- Use the control knob / push button to select the required warm water level.
- Click the control knob / push button to confirm the value.



TRUMA CP PLUS DIGITAL TIMER CONTROL

Select power type

- Click to change to the setting level.
- Use the control knob / push button to select the power type.
- Click the control knob / push button to confirm the value.



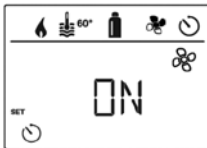
Select fan level

- Click to change to the setting level.
- Use the control knob / push button to select the required fan level.
- Click the control knob / push button to confirm the value.



Activate the timer (ON)

- Click to change to the setting level.
- Use the control knob / push button to activate the timer (ON)
- Click the control knob / push button to confirm the value.



Note: The timer remains active, even for several days, until it is deactivated (OFF).

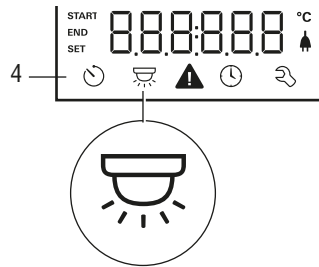
Deactivate the timer (OFF)

- Click to change to the setting level.
- Use the control knob / push button to deactivate the timer (OFF)
- Click the control knob / push button to confirm the value.



Switch lighting on/off

Available if an air conditioning unit is connected



Set time



- The hour display flashes.
- Use the control knob / push button to set the hours (24 h mode).
- After clicking the control knob / push button again, the minute display will flash.
- Use the control knob / push button to set the minutes.
- Click the control knob / push button to confirm the value.

Service menu

Query the index status of a connected device



Change the background lighting of the control panel

There are 5 background lighting levels to choose from.



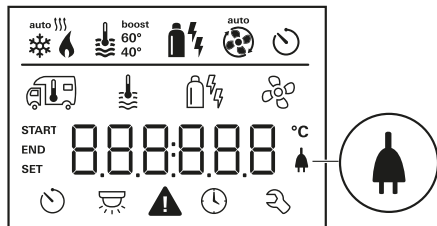
Change language

Select the required language from those available (e.g. English, German, French, Italian).



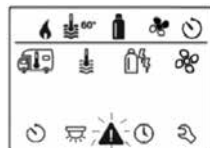
Display mains voltage 230 V

The symbol indicates that 230 V mains voltage (shore power) is available.



Warning

In the event of a warning, a warning symbol appears to indicate that an operating parameter has reached an undefined status. In this case, the affected device continues to run. As soon as the operating parameter returns to the set range, this symbol will turn off automatically.



Read out the warning code

- Use the control knob / push button to select the symbol.
- Click the control knob / push button. The current warning code is shown. The cause of the warning can be identified and rectified via the error list.



Cause rectified / return to setting level

- Click the control knob / push button.

Cause not rectified / return to setting level

- Press the Back button

Note: In this case, the warning is not acknowledged on the control panel and the warning symbol remains. The control panel remains in the warning status. Devices connected to the control panel can be operated.

TRUMA CP PLUS DIGITAL TIMER CONTROL

Malfunctions

In the case of a malfunction, the control panel immediately jumps to the menu level “malfunction” and shows the error code of the malfunction:



Cause remedied / return to setting level

- Click the control knob / push button.
- The respective device is restarted.

If the cause is not remedied, the malfunction will occur again and the control panel will jump again to the menu level “malfunction”.

Cause not remedied / return to setting level

- Press the Back button.

Note: In this case, the malfunction is not acknowledged in the control panel and the warning symbol remains on. The device remains in the malfunction status. Other devices connected to the control panel can be operated.

Maintenance

This device is maintenance-free. Use a non-abrasive damp cloth to clean the front. If this proves inadequate, use a neutral detergent.

Disposal

The device must be disposed of in compliance with the administrative provisions of the respective country in which it is used. The national regulations and laws (in Germany these are e.g. the End-of-Life Vehicle Regulations) must be observed.

Troubleshooting instructions (Combi Gas heater)

If these steps do not rectify the malfunction, please contact the Truma Service.

Error code	Cause	Remedy
#17	<ul style="list-style-type: none"> • Summer mode with empty water container • Warm air outlet blocked • Circulated air intake blocked 	<ul style="list-style-type: none"> • Switch device off and allow to cool. Fill boiler with water • Check each of the outlet openings • Remove the blockage from the circulated air intake
#18	<ul style="list-style-type: none"> • Gas pressure regulator frozen • Too much butane in the gas cylinder 	<ul style="list-style-type: none"> • Use the regulator heating (EisEx) • Use propane (Butane is unsuitable for heating, especially at temperatures below 10°C)
#21	<ul style="list-style-type: none"> • Room temperature sensor or cable faulty 	<ul style="list-style-type: none"> • Please contact the Truma Service
#24	<ul style="list-style-type: none"> • Potential under-voltage battery voltage too low <10.4V 	<ul style="list-style-type: none"> • Charge battery
#29	<ul style="list-style-type: none"> • Heating element for FrostControl has a short circuit 	<ul style="list-style-type: none"> • Disconnect the heating element plug on the electronic control unit. Replace heating element
#41	<ul style="list-style-type: none"> • Electronics are blocked 	<ul style="list-style-type: none"> • Please contact the Truma Service
#42	<ul style="list-style-type: none"> • Window above the cowl is open (window switch) 	<ul style="list-style-type: none"> • Close the window
#43	<ul style="list-style-type: none"> • Over-voltage > 16.4V 	<ul style="list-style-type: none"> • Check the battery voltage and voltage sources eg. the charger
#44	<ul style="list-style-type: none"> • Under-voltage battery voltage too low < 10.0V 	<ul style="list-style-type: none"> • Charge battery. Replace any old batteries
#45	<ul style="list-style-type: none"> • No 230V operating voltage • Faulty 230V fuse • Overheating protection has triggered 	<ul style="list-style-type: none"> • Reconnect the operating voltage 230V • Replace the 230V fuse • Reset the overheating protection. Allow the heating to cool down, remove the connection cover and press the reset button
#112	<ul style="list-style-type: none"> • Gas cylinder or quick-acting valve in the gas line closed 	<ul style="list-style-type: none"> • Check the gas supply and open the valves
#212	<ul style="list-style-type: none"> • Combustion air intake or exhaust outlet closed 	<ul style="list-style-type: none"> • Check the openings for soiling (snow, ice, leaves etc) and remove
#255	<ul style="list-style-type: none"> • No connection between the heater and the control panel • Control panel cable faulty 	<ul style="list-style-type: none"> • Please contact the Truma Service

TRUMA COMBI BOILER

Truma Combination Heating System Function Description

The liquid gas heater Combi E is a warm-air heater with integrated hot water boiler (10 liter volume). The burner operates fan-supported, which ensures trouble-free function even when on the move. The unit also has heating elements for electrical operation.

In winter operation the heater can be used to heat the room and simultaneously warm water.

3 different options are available for operating the unit.

- gas operation only Propane / Butane for autonomous use
- electrical operation only 230 V for stationary use on camp sites
- or gas and electrical operation – mixed operation only possible in winter mode.

Winter operation (Space heating with water heating)

In winter operation, the unit automatically selects the required power setting according to the temperature difference between the temperature set on the control panel and the current room temperature. When the boiler is filled, the water is automatically heated as well. The water temperature depends on the selected operational mode and the heater output. All 3 energy selection options can be used for winter deployment.

With gas operation the unit automatically selects the output level that is required. Depending on the fuse protection at the camping site, power of 900 W (3.9 A) or 1800 W (7.8 A) can be manually selected for electrical operation.

If more output is required (e.g. heating up or low outside temperatures) gas or mixed operation should be selected so that enough heating power is always available. With mixed operation, 230 V electrical operation is preferred if the power requirement is low (e.g. for maintaining the room temperature). The gas burner is not enabled until the power requirement is higher, and is the first to switch off during heat-up operations.

Summer operation (Water heating only)

Gas operation or 230 V electrical operation is used for hot water preparation. The water temperature can be set to 40 °C or 60 °C. With gas operation the water is heated at the lowest burner setting. Once the water temperature is reached, the burner switches off. Depending on the fuse protection at the camping site, power of 900 W (3.9 A) or

1800 W (7.8 A) can be manually selected for electrical operation. Mixed operation is not possible. With this

setting the unit automatically selects electrical operation. The gas burner is not enabled.

Repairs may only be carried out by an expert

Guarantee claims, warranty claims and acceptance of liability will be ruled out in the event of the following:

- modifications to the unit (including accessories),
- modifications to the exhaust duct and the cowl,
- failure to use original Truma parts as replacement parts and accessories,
- failure to follow the installation and operating instructions.

It also becomes illegal to use the appliance, and in some countries this even makes it illegal to use the vehicle.

During the initial operation of a brand new appliance (or after it has not been used for some time), a slight amount of fumes and smell may be noticed for a short while. It is a good idea to heat the device up several times in summer operation (60 °C) and to make sure that the area is well ventilated. Heat-sensitive objects such as spray cans

or flammable liquids may not be stored in the same compartment where the heater is installed because, under certain conditions, this area may be subject to elevated temperatures.

Important operating notes

The integrity and tight fit of the exhaust gas

double duct must be checked regularly, particularly at the end of long trips. Also check the mounting of the appliance and the cowl. Following a blow-back (misfire) always have the exhaust gas system checked by an expert! Always keep the cowl for the exhaust duct and combustion air intake free of contamination (slush, ice, leaves etc.). A number of hot air outlets and the recirculated air intake openings must be free so that the unit does not overheat. The integrated temperature limiter blocks the gas supply when the unit becomes too hot.

Operating Instructions

Always observe the operating instructions and "Important operating notes" prior to starting! The vehicle owner is responsible for the correct operation of the appliance. Before using for the first time, it is essential to flush the entire water supply system through with clean water. If the heater is not being used, always drain the water contents if there

is a risk of frost. There shall be no claims under guarantee for damage caused by frost!

Room thermostat

To measure the room temperature, a room temperature sensor is fitted to the furniture. The exact location is determined by the layout of the vehicle.

Taking into operation

Heating is possible without restrictions with gas, electrical and mixed operation, with or without water. Check to make sure the cowl is unobstructed. Be sure to remove any covers that may be present.

For operating on gas turn on gas cylinder and open the shut off valve at the manifold. For operating on electric operate the water heater switch on the power supply unit. See page 71.

Filling the water heater

Switch on power for water pump (main or pump switch) to prime the water system. Open hot water taps in kitchen and bathroom, (set preselecting mixing taps or single-lever fittings to "hot"). Leave the fittings open for as long as it takes for the boiler to displace the air and fill up, and the water to flow without interruption.

If just the cold water system is being operated, without using the water heater, the heater tank also fills up with water. To avoid frost damage, the boiler must be drained through the drain valve, even if the boiler was not operated.

When connecting to a central water supply (rural or city mains), a pressure reduction valve must always be installed to prevent pressures above 2.8 bar from developing in the water heater.

Draining the water heater

Switch off power to water pump (main or pump switch). Open hot water taps in kitchen and bathroom. In order to check the water that is flowing out, place an appropriate container (capacity 10 litres) beneath the drain valve.

Open the drain valve which is situated next to the boiler by lifting the yellow handle into the vertical position.

Check whether all of the water in the boiler (10 litres) has been drained into the container via the drain valve.

There shall be no claims under guarantee for damage caused by frost!

Maintenance

Only original Truma parts may be used for maintenance and repair work! Materials in the device which come into contact with water are suitable for use with drinking water (see manufacturer's declaration: [www.truma.com /](http://www.truma.com/) downloads / manufacturer's declaration).

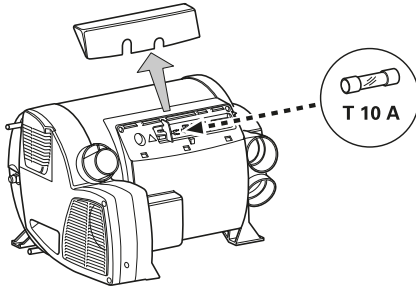
Bio-film, deposits and limescale must be removed using chemicals to protect the unit from infestation by microorganisms. Only chloride-free products must be used in order to prevent damage to the unit. The effectiveness of the use of chemicals to combat microorganisms in the unit can be increased by heating the water in the boiler to 70 °C at regular intervals. The unit must stay switched on for at least 30 minutes and no warm water may be removed. The residual heat in the heat exchanger will heat the water up to 70 °C.

TRUMA COMBI BOILER

Fuses 12 V

The fuse is in the electronics beneath the connection cover. Replace the unit's fuse only with an identical fuse.

Device fuse: 10 A – slow – (T 10 A)

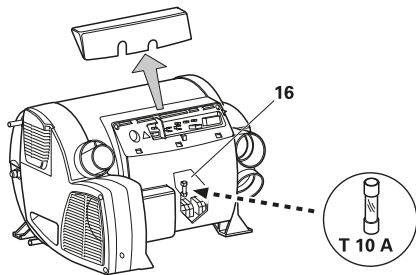


Fuses 230 V

The fuse and the power supply lines must only be replaced by an expert! The unit must be disconnected from the mains (all poles) before opening the electronic housing lid.

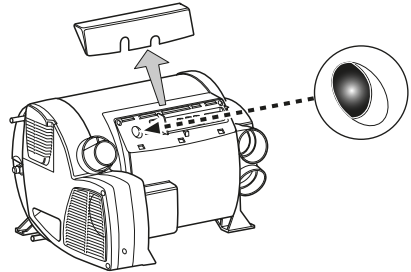
The fuse is in the power electronics (16) beneath the electronic housing lid.

This fine fuse must always be replaced with a fuse of the same type: 10 A, slow, interrupting capacity "H".



Overheating protection 230 V

The 230 V heating facility has a mechanical overheating switch. If the 12 V power supply is interrupted during operation or during the after-run period, for example, the temperatures within the unit could activate the overheating protection. To reset the overheating protection, allow heater to cool, remove connection protection, and press red reset button.



Technical data

determined in accordance with EN 624 or Truma test conditions

Device category

I₃ B/P in accordance with EN 437

Type of gas

Liquid gas (propane/butane)

Operating pressure

30mbar (see type plate)

Water contents

10 litres

Heating up time from approx 15°C to 60°C

Boiler approx 20 minutes (measure according to EN15033)

Heater + boiler approx 80 min

Water pressure

max 2.8 bar

Rated thermal output

(automatic output levels)

Gas operation

Combi 4 E: 2000 W / 4000 W

Combi 6 E: 2000 W / 4000 W / 6000W

Electrical operation

Combi 4 E / Combi 6 E: 900 W / 1800 W

Mixed operation (gas and electrical)

Combi 4 E: max. 3800 W

Combi 6 E: max. 5800 W

Gas consumption

Combi 4 E: 160-320 g/h

Combi 6 E: 160-480 g/h

Readiness-heat power requirement Combi 4 E

/ Combi 6 E:

Gas operation 5.2 g/h

Air delivery volume

(free-blowing without hot-air pipe)

Combi 4 E:

with 3 hot-air outlets max. 249 m³/h

with 4 hot-air outlets max. 287 m³/h

Combi 6 E:

with 4 hot-air outlets max. 287 m³/h

Current input at 12 V

Heater +boiler

Combi 4 E: Short-term max. 5.6 A
(average power consumption 1.1 A)

Combi 6 E: Short-term max. 5.6 A
(average power consumption 1.3 A)

Heating up of boiler: 0.4 A

Stand-by: 0.001 A

Heating element FrostControl (optional):
maximum 0.4 A

Alde Compact 3010

Challenger and Eccles SE, Conqueror, Elite and Cameo based models



Please read these instructions carefully before using the boiler.

These instructions are approved for The Alde Compact 3010 boiler fitted in caravans, motor caravans and buildings in accordance with CE no. EMC e5 02 0138, 845 BP-0003.

Installation and repairs may only be carried out by a professional. National regulations must be adhered to.

Boiler design

The boiler consists of three eccentrically-fitted cylinders (heat exchanger, water jacket for the heating system and, outermost, water jacket for hot water). The two outer pipes, and their ends and connections, are made of stainless steel, while the heat exchanger is made of aluminium.

The heat exchanger is divided into two semi-circles. The burner is located in the upper half, being the combustion chamber, and the combustion gases are expelled through the lower half. The burner unit is fitted on the end of the heat exchanger. It consists of a combustion fan, burner, solenoid valve and intake/exhaust connections. Two heating cartridges are fitted to the water jacket of the heating system. Maximum output is 2 or 3 kW, depending on model.

Description of functions

Using LPG

When LPG operation is selected on the control panel, the combustion fan starts. When the fan speed is correct, it signals the circuit board that the boiler can be lit. The circuit board sends ignition sparks to the spark plug at the same time as it sends electricity to the solenoid valve, which opens to allow gas in. The burner ignites, and a sensor transmits a signal back to the circuit board that the boiler is lit, and the ignition spark stops. The burner keeps burning until the boiler thermostat or the room thermostat reaches the set temperature reading.

Should the boiler go out for any reason, the sensor is activated and a new attempt is made to start the boiler (in about 10 seconds).

Using the heating cartridge

Electrical operation is selected on the control panel, the 12-volt relays on the circuit board trip, allowing the 230 volt supply to reach the electrical elements.

The heating cartridge is controlled in the same way as the gas boiler.

Warm water

When only warm water is required, for example during the summer, no settings need to be made, the boiler will look after this function automatically.

The pump will only start when the temperature in the vehicle is lower than the set temperature (see item 4, Control Panel). If the vehicle temperature is higher, the pump will not start.

Important information

- The boiler must not be started if there is no glycol in the system.
- The LPG boiler and heating cartridge may be operated in parallel.
- The heating system may be heated up without the warm water heater being filled with fresh water.
- Always switch off the main isolator for the boiler when the vehicle is not being used.
- Always drain the warm water heater of fresh water if there is a risk of frost.
- The LPG boiler must not be operated when refuelling the vehicle.
- When washing the vehicle, take care not to get water in the venting.

⚠ WARNING: Care should be taken to ensure adequate ventilation of the flue at all times. Its is inadvisable to inhale exhaust fumes.

The Domestic hot water heater

The boiler is fitted with a built-in warm water heater with a volume of approx. 8.5-litres fresh water. The warm water heater can produce around 12 litres of 40°C water per half-hour (at a cold water temperature of 10°C). If the heating cartridges are used instead of gas for heating the boiler, the capacity is slightly reduced. Always rinse out the heater before it is used, particularly if it has not been in operation for some time.

Note: The hot water is not intended for drinking or cooking.

When the heater is in continuous use, it should be emptied approx. once a month, to ensure that a new air cushion is formed in the heater.

The air cushion is essential for absorbing pressure surges in the heater.

Note: The warm water heater should always be drained of fresh water when there is a risk of frost and when the caravan is not in use.

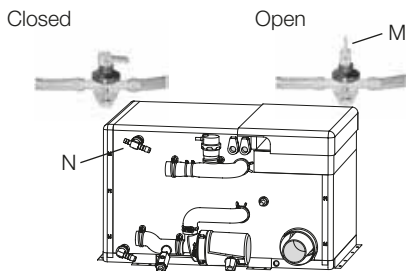
The warranty does not cover frost damage.

Draining the heater using the combined safety/drain valve:

1. Switch off the freshwater pump
2. Open all water taps.
3. Then open the safety/drain valve by raising the yellow lever (M) to a vertical position.
4. The heater will now drain directly below the vehicle through the safety/drain valve hose. Check that all the water is emptied out (about 7-10 litres). Leave the valve in the open position until the next time the heater is used.

Note: Check that the automatic check valve (N) is open and is allowing air to enter the heater when it is being drained, and that the hose (O) is not blocked.

ALDE HEATING OPERATING INSTRUCTIONS



The heating cartridges

All Compact 3010s are fitted with two 230V heating cartridges with a maximum output of either 2100 or 3150W. Select the heating cartridge output on the control panel.

Always check that the input supply of the vehicle has the correct amperage in relation to the selected output.

Note these ratings are for the boiler only.

1050W requires a 6 amp fuse/supply.

2100W requires a 10 amp fuse/supply.

3150W requires a 16 amp fuse/supply.

The circulation pump

A circulation pump is required to circulate the heated glycol fluid. A 12V circulation pump is fitted in the expansion tank.

An optional 230V circulation pump can be fitted on the boiler. Selection of circulation pump is made with a switch on the control panel. The room thermostat on the control panel controls the circulation pump, i.e. switches it on or off according to the amount of heat required.

System temperature

The boiler is set to a system temperature of 80°C, i.e. the temperature of the glycol fluid as it circulates in the heating system.

Air circulation

In order to achieve the best possible result from the principle of convected heat, it is important to allow air to circulate freely under bunks, and behind backrests and wall-mounted cabinets.

If the vehicle has a fitted carpet, ensure that the carpet does not obstruct the air supply to the radiators.

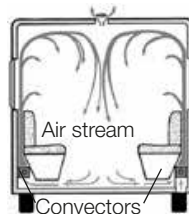
It is just as important that cushions or blankets do not interrupt the flow of air behind backrests and wall cabinets.

Note: During the first weeks of ownership customers may notice a drop in the glycol level and/or blocked radiators. This is normal as the system settles.

Maintaining the heating system

Winter camping

While camping during the winter, ensure that the flue is kept clear of snow and ice, since the inlet air to the LPG boiler enters through the flue. Do not start the LPG boiler until the flue is completely free of snow. A flue extension (part no. 3000 320) for fitting on the roof is recommended for winter camping.



The heating system

Regularly check the heating system's fluid level in the expansion tank. The level should be about 1cm above the minimum indicator in a cold tank. The heating system should be filled with a mixture of water and glycol.

For preference, use high quality ready mixed glycol (with inhibitor) intended for use in aluminium heating systems.

If using concentrated glycol, the mixture should consist of 50% water and 50% glycol. If the heating system will be exposed to temperatures below -25°C, the glycol content must be increased, but not to more than 50%. Any vessels used for the liquid must be spotlessly clean, and the pipes in the heating system must be free of contamination. This will prevent the growth of bacteria in the system.

The glycol mixture should be changed every second year, since its ability to protect against corrosion, for example, will deteriorate. The glycol content should be checked before topping up with new liquid. This will ensure that the concentration of glycol in the mixture is not too high.

If the fluid level in the expansion tank falls for reasons other than evaporation, please check all joints, drain cocks and bleeder screws to ensure that they are not leaking. If the glycol-water mixture leaks out, rinse with water and wipe up.

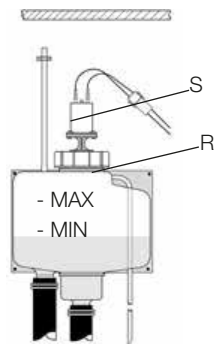
Never allow the heating system to stand empty of glycol.

Filling the system with glycol fluid

Note: Any vessels used to carry the fluid must be spotlessly clean and the pipes in the system must be free of contamination. This will prevent the growth of bacteria in the system.

The system is filled through the expansion tank, either manually or using the Alde filling pump which both tops up and bleeds the system. For manual filling, unfasten the circulation pump nut (R) and lift the pump (S) out of the tank. Slowly pour the glycol mixture into the tank. Bleed the system.

Top up with more liquid if the level has fallen after bleeding. Bleed a newly filled system regularly during the first days the heating system is in operation.



Types of glycol

Various types of antifreeze (as used in car radiators) are available from service stations, car accessory shops and on line retailers and these types of antifreeze can be used to top up or replace the heating system fluid in the Alde heating system.

Frost and corrosion damage are not covered under warranty, so it is important that the type purchased contains corrosion inhibitors suitable for use with aluminium systems. Always check the label, ask the retailer for advice, or check with your supplying dealer if unsure. Please note the corrosion inhibitor will have a limited life, and after it expires, the system will have no corrosion protection.

The fluid will usually be named as Ethylene glycol, but may also be described as monoethylene glycol, MEG, ethanediol, or G12++. There is no industry standard for the colour of the antifreeze, but as a general guideline it indicates the type of corrosion inhibitor:

Blue, Green - Silicate inhibitor, usually offering 2-year corrosion protection

Red, Orange - OAT inhibitor, usually offering 5-year corrosion protection

Purple, Magenta - G12++ Silicated OAT inhibitor, usually offering 5 year corrosion protection

It is important that antifreeze containing Silicate inhibitor (Blue or Green) is not mixed with antifreeze containing OAT inhibitor (Red or Orange). To guarantee compatibility, there are two options:

1. Match the colour, taking care to also check the label on the antifreeze bottle, i.e. if the system is filled with blue silicate-containing antifreeze, top up with blue silicate-containing antifreeze.
2. Use G12++ antifreeze which is compatible with any of the other types of inhibitor described.

ALDE HEATING OPERATING INSTRUCTIONS

Bleeding the system

Depending on how the pipes have been fitted, air pockets may form when the system is filled with glycol fluid.

A sign that there is air trapped in the system is that the heat released into the pipes only extends a metre or so from the boiler even though the circulation pump is operating.

In newly-filled systems, small air bubbles can form in the expansion tank, creating a murmuring sound. If the circulation pump is stopped for a few seconds, the bubbles will disappear.

Bleeding:

If a bleeder screw is fitted to the outgoing pipe, open this bleeder screw and leave it open until it starts to discharge water.

If the boiler is fitted with an automatic bleeder, there is no need to bleed it manually. Start the LPG boiler. The circulation pump should be switched off.

Open the remaining bleeder screws in the system (please refer to the instruction manual of the vehicle for their locations). Leave the bleeder screws open until they start discharging fluid, and then close them. Start the circulation pump and let it run for a while. Check that the pipes and radiators around the vehicle are heating up.

If there are still issues, try the following:**Single-axle caravan:**

Stop the circulation pump. Lower the front of the caravan as far as possible. Leave it in this position for a few minutes to allow the air to travel upwards in the system. Open the bleeder screw at the highest point. Leave it open until it discharges glycol fluid. Raise the front of the caravan as far as possible and repeat the procedure in this position.

Then position the caravan horizontally and start the circulation pump. Check that the pipes and radiators around the vehicle are heating up.

Twin-axle caravan:

The easiest way to bleed the heating system is to place the vehicle on a sloping surface or to raise one end of the vehicle using a jack. Bleed the system as described above.

Fault finding**The boiler does not start**

1. No LPG? Incorrect type for conditions?
2. Is the main tap fully open?
3. If the boiler has not been operated for some time, or if the gas cylinder has been changed, it may take longer than normal to light the boiler.
4. Check that the boiler is connected to the electricity supply (> 11V).
5. Check that the fuse (T) for the boiler is intact.
6. Check whether the electric connections on the boiler are securely in position.

If none of the above helps, contact a service workshop.

The heating cartridge is not working

1. Check that there is an electricity supply (230V ~) to the heating cartridge.
2. Check that the relays fitted to the boiler come on (a slight click can be heard from the relays when the heating cartridge is switched on at the control panel).

If none of the above helps, contact a service workshop.

Operating instructions control panel 3010 613

Please read these instructions carefully before using the boiler. For Operating and Installation Instructions of boiler, please see separate instruction. These instructions are for the Alde Compact 3010 boiler fitted in vehicles, boats and buildings in accordance with CE no. 0845 BP0003, installation in vehicles e500 00005 and EMC e5 03 261. Installation and repairs may only be carried out by a professional. National regulations must be adhered to.

1. Starting the boiler

1. The control panel and the boiler are switched off.



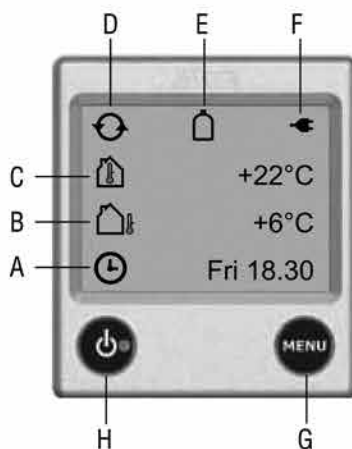
2. To start the boiler, press the On/Off button and the start-up display is displayed. The boiler starts with the last selected setting.



A green LED comes on beside the On-/Off button when the panel/boiler is on.

2. The control panel in standby mode

Note: if “Standby Brightness” is set to Off, the display goes out when it enters standby mode, but lights up if you press the screen. See settings under 9.12.



A. Clock

The clock shows day and time. The clock is set under section 9 point 2.

B. Outdoor temperature

The outdoor temperature is displayed only if an outdoor temperature sensor is fitted.

C. Indoor temperature

The indoor temperature is displayed automatically.

D. Circulation pump

This symbol is displayed when circulation of the central heating is called for.

E. LPG bottle full/empty

This symbol is displayed when the sensor on the cylinder changeover is connected and activated in accordance with section 9 point 8.

F. 230 volts

This symbol is displayed when 230V is connected to the boiler.

G. MENU button

Button for setting menu.

ALDE HEATING OPERATING INSTRUCTIONS

H. On/Off button

Shut down / turn on the boiler

3. From standby mode to setting menu

When on standby, the indoor temperature is displayed, and the outdoor temperature is displayed if an outdoor temperature sensor has been connected. The background lights up when you press the screen or the MENU button. Start the setting menu by pressing the MENU button. The background lights up and those functions which can be set are displayed. The settings are automatically saved after 10 seconds. The control panel reverts to standby automatically after 30 seconds if no buttons are pressed (or if the MENU button in the setting menu is pressed).

1. The control panel in standby.



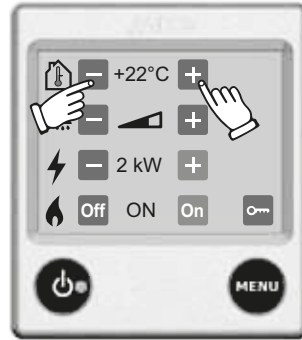
2. The control panel in setting menu.



Note: if “Standby Brightness” is set to Off, the display goes out when it enters standby mode, but lights up if you press the screen. See settings under 9.12.

4. Set the required temperature

The temperature can be set from +5°C to +30°C in steps of 0.5°C. Warm water is always available (50°C) when the boiler is on and running on LPG and/or electricity. During summer, when only warm water is required, adjust the temperature setting to well below the surrounding temperature so that central heating circulation is not called for.



1. The temperature displayed is the temperature which is set at present (in this case 22.0°C).
2. Raise the temperature by pressing the + button. Lower the temperature by pressing the - button.
3. The settings are ready and the central heating will circulate at the set temperature.

5. Hot water boost

If you need more warm water, you can raise the water temperature temporarily from 50°C to 65°C. After 30 minutes, the boiler reverts to normal operation. While hot water boost is activated, the circulation pump is stopped.



1. Increase the quantity of warm water by pressing the + button. When activated the plus symbol changes colour to green.
2. The settings are ready.

If you wish to revert to the basic warm water settings before 30 minutes have expired.



1. Start and step between the various power steps (Off, 1kW, 2kW or 3kW) with the + button or - button. The set value is displayed on the screen. When activated the plus symbol changes colour to green. (Certain boilers are equipped with max 2 kW, selecting 3kW is not possible in these cases.)

2. The settings are ready and the boiler is working at set temperature.
3. To switch off the electrical operation, step with the - button to Off.



1. Reset the warm water by pressing the - button.
2. The settings are ready.

6. Heating with electricity

Do as follows to active heating with electricity. The greater the power, the better the heating performance. In choosing between electricity and gas, electricity is given priority.

7. Heating with gas

Do as follows to activate heating with gas. If both electricity and gas are selected, electricity is given priority.



1. Start the gas operation by pressing On. The On symbol is activated and changes colour to green.

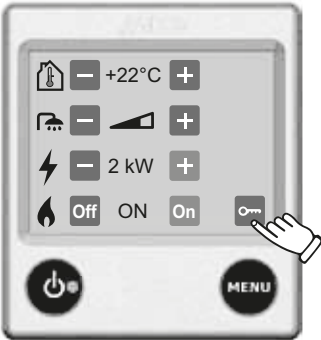
ALDE HEATING OPERATING INSTRUCTIONS

2. The settings are ready and the boiler is working at set temperature.
3. In order to switch off gas operation, press Off.

8. Unlocking the tool menu

It is possible to go from the setting menu to the tool menu. Under the tool menu you can access the other functions of the control panel, described in section 9.

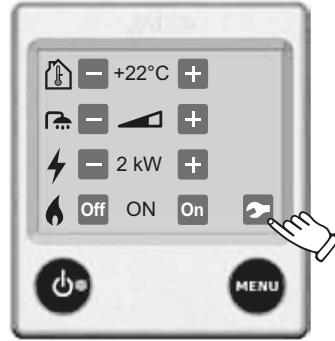
1. The control panel in setting menu. Press the unlock symbol.



2. The control panel in unlocking menu. Press on open padlock, then OK or MENU to unlock the tools menu. When activated the symbol changes colour to green.



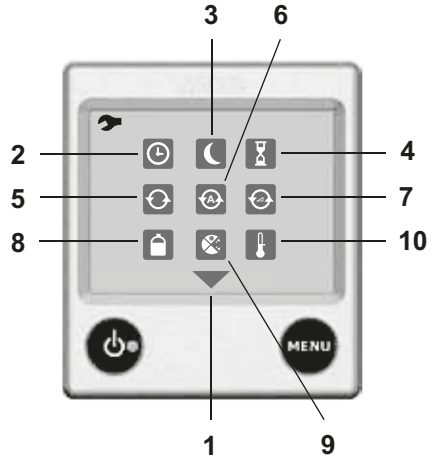
3. The control panel in setting menu with unlocked tool menu. In order to get to the tool menu, press the symbol.

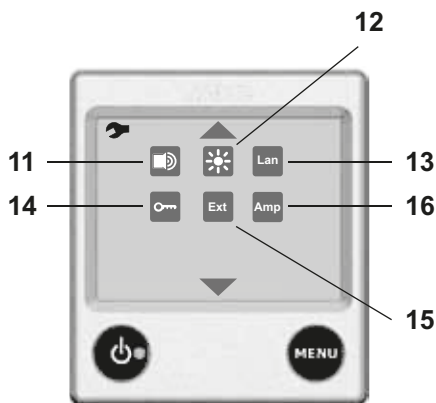


9. The tool menu - functions

When you are in the tool menu (see section 8), you can use the tools described below. Step between the various tool fields by pressing the up or down arrow symbols. You can always leave the tool menu with the MENU button.

Note: Functions marked with * indicate that the symbol for the function is displayed on the control panel even if the accessory is not installed!





1. Arrow symbols

Step between the various tool fields by pressing the up or down arrow symbols. You can always leave the tool menu with the MENU button.



2. Clock

The clock must be set if automatic nighttime mode or automatic start is to be used. If 12V voltage is lost, the clock will be reset and correct time will no longer be displayed. This is prevented with an optional AA battery backup.



3. Automatic night-time mode

This function is used when you want to programme the central heating to automatically lower the temperature at night and raise the temperature in the morning.



4. Starting the boiler automatically

This function is used to start the boiler automatically at a later point of time. With automatic start, the boiler works for 24 hours and then stops. After that, it repeats the automatic start once a week; at the same day and time, as long as the function is activated. For automatic start to function, the On/Off button must be set in the OFF position.



5. Constant pump operation

Cont.: With this function selected the pump is permanently on. (NB., this

function limits the supply of hot water, particularly when there is a low heating requirement) Therm: With this function selected the pump is controlled by the panel/room sensor. This is the normal operating mode for heating the vehicle and obtaining a normal supply of hot water. Factory setting is Therm.



6. *Pump Auto / 12V

In the Auto mode, the 230V pump operates, and when 230V is disconnected, the 12V pump starts. In 12V mode, the 12V pump is used even if 230V is connected. The Auto function is activated in the factory setting.



7. *Pump speed

The circulation pump's capacity can be remote controlled from the panel.

Note: A pump with remote control must be installed in order that this function can be used (see the manual for the vehicle, boat or building).



8. *LPG bottle full/empty

This function is used in combination with the cylinder changeover (DuoComfort or DuoControl) and indicates if the LPG bottle is full or empty. This function can also be used to control defroster heating of the cylinder changeover using an EisEx defroster.

Note: The cylinder changeover (DuoComfort or DuoControl) must be installed in order for this function to work (see the manual for the vehicle, boat or building).



9. Automatic anti-bacterial mode (legionella)

At 02.00 at night (if the clock is set) the boiler starts and works according to "Hot water boost" (see section 5). This is in order to reduce the risk of legionella. The function is deactivated in the factory setting.

ALDE HEATING OPERATING INSTRUCTIONS



10. Offset (temperature adjustment)

Using this function, you can calibrate the temperature on the panel if you notice that the temperature (the stabilised room temperature) is not the same as the temperature shown on the panel. This also applies to outdoor temperature.



11. Button sound

With this function, you can activate or deactivate the button sound. The button sound is activated in the factory setting.



12. Screen Brightness

Brightness: The brightness of the display (working mode) can be adjusted from 1 to 10. Factory setting is 5.

Standby brightness:

Off: Used to turn the display's backlighting off so that the display is turned off (becomes dark) in standby mode (the LED is still active).

On: Used to activate the backlighting in the display (low lighting) in standby mode (the LED is still active). Factory setting is On.

Lan

13. Language

This function is used to reset the screen between different languages. Available languages are: English, French and German. On the other hand, the service menu is only in English (see section 10.1).



14. Tools / Key

Under Tools / Key you can lock or unlock access to the tool menu.

Ext

15. *External start

This function is used when starting the boiler from the outside, for example, with GSM. When external start has been activated, the control panel's On/Off button must be switched off (see the assembly setting manual for external start).

Note: To use this function, an external start installation is required (see the manual for the vehicle, boat or building).

*230 V

This function is used in connection with starting the boiler when connection of 230 V to vehicle takes place from outside. When the 230 V function has been activated the control panel's on/off button must be turned off, but 12 V must be connected (the vehicle's main switch is on). Before turning off the control panel with the on-/ off button set the parameters/functions that you want the boiler to have when it starts (230 V is connected).

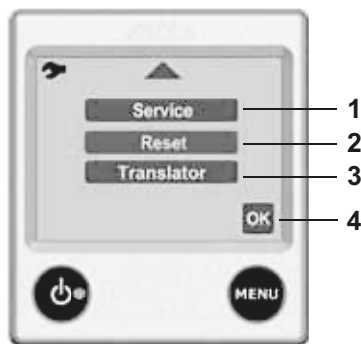
Amp

16. *Load monitor

This function is used to prevent the 230V fuses being overloaded. If the total power consumption of the vehicle, boat or building exceeds the set value, the boiler's power will be automatically reduced. On account of voltage variations and tolerances, different setting levels can be selected (for example, for 6A fuse, one can choose 6 or 7 Amp setting). If the fuse does not hold, choose a lower set value. The function is deactivated in the factory setting.

Note: The load monitor has to be installed for the function to be used (see the manual for the vehicle, boat or building).

10. Service and Resetting the system



1. Service

With this function, you can see certain values of the boiler on the screen. The values are updated once a second

2. Resetting the system

With this function the panel can be reset to factory setting. After resetting, the panel is set as follows: the boiler in Off mode, electrical operation 1kw, LPG heating in On mode and indoor temperature 22°C. Other functions are disconnected.

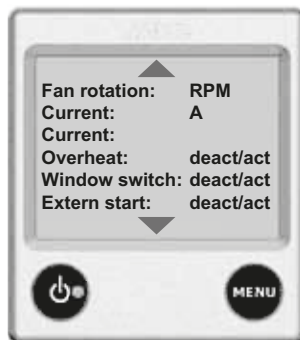
3. Translator

This function is used to enable an external main panel to operate the boiler. If a main panel is connected to the Alde panel, it is activated with the On button, otherwise it must always be set at Off. Factory setting is Off.

4. OK

To leave the tool menu, press OK or Menu.

Service menus



ALDE HEATING OPERATING INSTRUCTIONS

11. Fault messages



If an error occurs in the system, the display will show the reason. This is only displayed when the panel is on standby.

Battery too low: If the vehicle, boat or building has a battery voltage of less than 10.5V, the boiler stops. It is automatically reset when the voltage reaches 11V.

Fan failure: Faulty fan speed. In order to reset, disconnect 12V from the boiler and reconnect (automatic reset after 5 minutes).

Gas failure: Gas finished. Reset by switching off and restarting the boiler in accordance with item 1.

Overheat red fail: Overheating protection (red cable) triggered. To reset, disconnect 12V from the boiler and reconnect.

Overheat blue fail: Overheating protection (blue cable) triggered. To reset, disconnect 12V from the boiler and reconnect.

Window open: Window open, the boiler stops for gas. Gas operation in the boiler starts again when the window is closed. The electrical operation remains in function. Check the vehicle, boat or building manual to see whether this function is installed.

Connection failure: There is a connection fault between boiler and panel. To reset, disconnect 12V from the boiler and reconnect.

Connection fail ext: Communication error between Alde's panel and external panel.

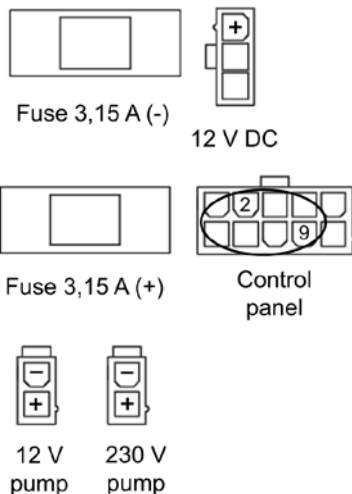
Panel failure 1: Panel fault.

Panel failure 2: Panel fault.

12. Emergency start

- Disconnect the 12V cable and the cable to the panel on the boiler.
- Connect a cable between 2 and 9 in the connector on the boiler.
- Reconnect 12V to the boiler

Now the boiler starts with gas and 1kW. Adjustment of the room temperature is not working. Constant pump operation is set.



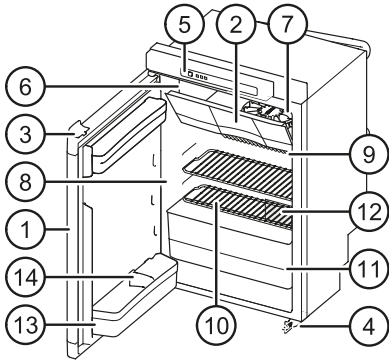
Thetford refrigerator

Sprite, Challenger and Eccles Sport based models

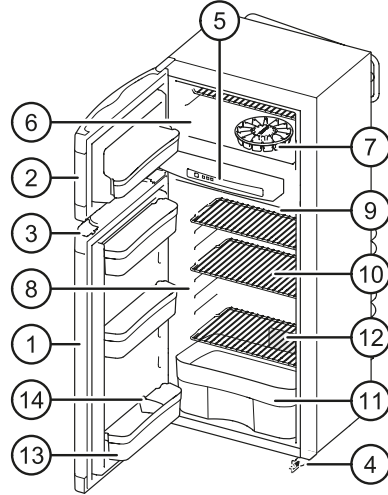
Instructions for use

N3000-E series with LED control panel

model A

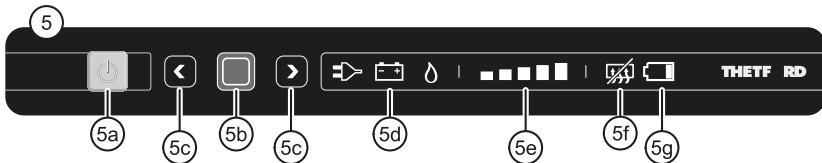


model B



LED-control panel

(N3000-A series with touchscreen)



Main parts

1. Refrigerator door
2. Freezer door
3. Door lock
4. Security lock (dependent on model)
5. Control panel LED

- 5a. On/off switch
- 5b. Confirmation button
- 5c. Arrow buttons
- 5d. Symbols sources
- 5e. Cooling level indicators

THETFORD REFRIGERATOR

- 5f. Symbol 'anti-condensation (only for model B)
- 5g. Symbol 'batteries empty' (optional extra)
- 6. Freezer compartment
- 7. Ice cube tray
- 8. Refrigerator compartment
- 9. Cooling fins
- 10. Storage shelves
- 11. ,Vegetable bin
- 12. Serial label
- 13. Door bins
- 14. Bottle retainer

Introduction

This Thetford refrigerator is specially developed for caravans or motorhomes. It meets high quality standards, is user friendly and gives you all the convenience during holidays and short trips.

Before operating and using this refrigerator we advise you to read the manual completely. Keep this manual in a safe place for future reference.

For the latest version of the manual please visit www.thetford-europe.com

Use safely

For correct and safe use of this refrigerator, you need to observe several precautions and general recommendations. If these instructions have not been followed, warranty claims will not be accepted.

⚠ WARNING: What to do if you smell gas. Directly close the valve of the gas bottle, extinguish any naked flames, do not switch on any electrical devices or lighting, open the windows and leave the room. Then contact the Customer Service Department in your country or holiday location.

⚠ WARNING: What to do if you smell a pungent odour from the cooling system. Switch off the refrigerator, extinguish any naked flames, provide sufficient ventilation through vents, windows and doors. Then contact the Customer Service Department in your country or holiday location.

Maintenance

- Make sure that installation, electrical connection, maintenance and periodical inspection of the gas system will be done by a qualified technical person, according to Thetford's instructions (www.thetford-europe.com) and local safety rules;
- Never open or damage the cooling system at the back of your refrigerator. The cooling system is pressurised and contains substances that are harmful to your health;
- Never attempt to repair parts of the gas system, the gas flue or electrical components yourself. The repairs may only be done by a qualified party. Please contact the Customer Service Department for further support and addresses;
- Before carrying out any kind of maintenance or cleaning, switch off your refrigerator;
- Never expose the refrigerator to rain.

Use of gas

- The refrigerator only runs on liquid gas (propane, butane or a mixture of these both). It does not run on natural gas or coal gas;
- Only use gas which is mentioned on the serial label inside the refrigerator;
- It is recommended to use an additional filter when operating on Liquefied Petroleum Gas (LPG);
- Make sure the type and position of the gas bottle meets the latest technical regulations;
- Change the gas bottle in open air and out of reach of any possible source of ignition;
- Never obstruct the ventilation openings in the gas bottle storage location;

- Keep flammable material away from the refrigerator;
- Do not use gas to power your refrigerator in the vicinity of petrol stations.

Food

- Respect the expiry date printed on the packaging of food;
- Defrosting, cleaning or maintenance of the refrigerator can shorten the preservability of food.

Switch on refrigerator

Note: To secure optimal performance, level your vehicle before operating the refrigerator.

Note: We advise to clean the inside of the refrigerator properly, before using the refrigerator.

To switch on the refrigerator, press the on/off switch and hold it for 1 second. A light in the on/off switch will turn green.

Note: After 10 seconds the settings will dim. The green light indicates the refrigerator is still in function.

To check the settings push the confirmation button. The last selected settings will light up.

For optimal performance, switch on the refrigerator 8 hours before placing food in it.

Selecting source

After switching on the refrigerator, push the confirmation button and hold it for two seconds. The symbols for the sources light up and start to blink.

Choose the desired source by pushing the arrow buttons.

Confirm your choice with the confirmation button.

Sources



220V
240V

The refrigerator is powered by the mains.



12V

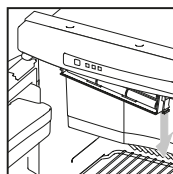
The refrigerator is powered by the battery of your vehicle.



Gas

The refrigerator is powered by the connection of a gas bottle.

Note: The refrigerator is only operated, when the control panel is powered. A stand alone model (installed by your dealer) is operational using AA batteries in the event of no mains or battery.



Therefore open the small cover underneath the control panel, as illustrated. Place 6 new 1.5 V AA/LR6 batteries, according to the illustration in the cover.

Note: Always use the gas connection or mains voltage to start up and cool. Operating on 12 V is only effective while the engine of the vehicle is running.

Note: The performance of the refrigerator, by operating on 12 V, is dependant on the thickness and length of the wiring and the overall installation of the vehicle.

Note: When selecting gas, the flame should be ignited within 30 seconds. If the system fails, restart the refrigerator and select the gas source again.

Note: From about 1000m above sea level problems of a physical nature can occur when lighting the gas. This does not mean that the refrigerator is not working properly..

THETFORD REFRIGERATOR

Selecting cooling level

After switching on the refrigerator, push the confirmation button and hold it for two seconds.

The symbols for the sources start to blink. Push the confirmation button again.

The cooling level indicators start to blink. Use the arrow button to choose the desired cooling level.

Confirm your choice with the confirmation button.



Lowest cooling level Highest cooling level

Your refrigerator meets the climate class SN requirements according to EN/IOS 7371 at a temperature of 10°C to 32°C.

Note: We advise to set the refrigerator on cooling level 3, with an ambient temperature between 15°C and 25°C. A higher temperature needs a higher cooling level, a lower temperature a lower level.

Note: To improve the cooling performance of your refrigerator in high temperatures, Thetford advises to install the Ventilator Kit. It helps to detract the warm air quicker to the vents. The Ventilator Kit is suitable for all Thetford refrigerators.

Control of optional extras

Batteries empty (present with the stand alone models, installed by your dealer)

When your refrigerator is provided with the stand-alone option, it will run 1.5 V AA / LR6 batteries for approximately 7 days in combination with gas supply. When the red symbol 'batteries empty' blinks, you have to replace batteries within 24 hours.

Remove all batteries out of the small cover underneath the control panel and replace 6 new batteries.

⚠ WARNING: Only use 1.5 V AA/LR6 batteries. Do not use rechargeable batteries for this function in the refrigerator.

Note: If you are not going to use this function for more than two weeks, remove all batteries.

Note: If you don't have enough batteries or want to use your refrigerator for a very short period it is possible to use only 3 batteries in a row. Your refrigerator will run for approximately half a week now.

Anti-condensation (present on model B)

To prevent the control panel from condensation, the anti-condensation function is automatically switched on. Only switch off this function when little energy is present.

Push both arrow buttons together at once and hold them for 2 seconds. The symbol 'anti-condensation off' will light up on the control. To switch on the function again, push both arrow buttons for 2 seconds once more.

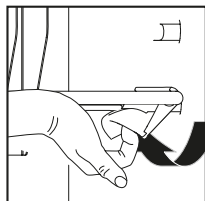
Note: When your refrigerator runs on AA batteries, anti-condensation is switched off automatically.

Use of refrigerator compartment

You can organise your refrigerator as desired by moving the storage shelves and door bins in height.

Note: Make sure the door can still be closed after reorganising shelves and bins.

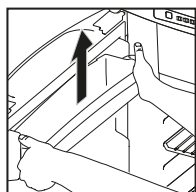
Moving storage shelves



Turn the plastic clamp on the right side of the storage shelf upwards, as illustrated. Lift the right side a bit, and move the storage shelf to the desired position.

First place the left side of the storage shelf in the refrigerator wall, then the right side in the corresponding groove. Turn the plastic clamp downwards. Your storage shelf is fixated again.

Moving door bins



Push a door bin out of the locking with both hands, as illustrated. Place this door bin back in the desired position and push it back on the locking. The door bin is fixated again.

Organising food

After a minimum of 8 hours of cooling, the food can be placed in the refrigerator. Do not completely cover the cooling fins with food, to preserve an optimal performance of the refrigerator. Make sure air can still circulate around the fins.

Note: To prevent your refrigerator from ice formation, always cover liquid products, let warm products cool down before placing them in the refrigerator and don't open the door longer than necessary.

Note: To reduce cooling time, store only pre-cooled foods in the refrigerator.

Note: To prevent the food from drying out or your refrigerator from odours, store food separately in closed boxes.

Use of freezer compartment

You can use the freezer compartment to keep food frozen or to make ice cubes with the special delivered tray.

CAUTION! Never keep carbonated liquids in the freezer compartment.

CAUTION! If the refrigerator has to perform for a longer period in internal vehicle temperature below 10°C, a constant regulation of temperature in the freezer compartment can't be guaranteed. The temperature can increase and the food may defrost in the freezer compartment.

Making ice cubes

Fill 2/3 of the ice cube with water and put the tray in the freezer compartment. Make sure you only use drinking water.

CAUTION! Never eat ice cubes or popsicles directly out of the freezer compartment. This can cause burn wounds.

Note: To quicken the process, make ice cubes at night, when the refrigerator has more capacity. Place the ice cube tray in an empty freezer on the bottom and the back.

While driving

WARNING: In Europe it is only allowed to run your refrigerator on gas while driving, if a gas system with break protection is installed and local regulations are respected.

Note: Because of varying outside conditions during driving, good performance on gas can't be guaranteed. Therefore Thetford does not advise to run your refrigerator on gas while driving.

Make sure all products in your refrigerator can't move while driving. Secure the bottles in the door with the bottle retainer and fixate all food on the storage shelves.

THETFORD REFRIGERATOR

Door lock

When you close and press the door of the refrigerator, the door locks automatically. While driving this door lock also secures the door. Some models have an extra security lock on the bottom of the refrigerator. To be sure the door will not open while driving, push the black security lock over the pin on the door.

⚠ WARNING: Never let children play or hide in the refrigerator. Children can be trapped and possibly suffocate.

Winter use

When you are going to use the refrigerator with an outside temperature below 10°C, install a suitable winter cover.

This cover will protect your refrigerator against too cold air and makes sure the refrigerator will still perform optimally.

Make sure you remove the winter cover again once the temperature is above 10°C.

Cleaning

It is important to regularly clean the refrigerator for optimal performance. Clean the inside with a soft cloth and a mild household cleaner. Use a wet, soft cloth for the outside of the refrigerator. Make sure the vents on the outside of the vehicle are always dust-tight.

⚠ WARNING: Never clean your refrigerator with soap or aggressive, caustic or soda-based cleaning agents.

⚠ WARNING: The loose parts of the refrigerator are not suitable for the dishwasher.

⚠ WARNING: Water through the vents may damage your refrigerator. Therefore install winter covers before washing your vehicle.

Switch off refrigerator

Before defrosting the refrigerator or sorting your vehicle, switch off the refrigerator. Push the on/off switch and hold it for 2 seconds to switch off the refrigerator. All lights will go out.

Defrosting

A layer of ice on the cooling fins will decrease the cooling capacity and durability of your refrigerator. Therefore your refrigerator is provided with an automatic defrost system, which prevents ice formation.

Despite this system, it is also possible to manually defrost your refrigerator on occasion. Remove all food, wrap it tightly in newspaper and put it on a cold place or in an insulated bag. Then open the doors. Put dry towels in the refrigerator to catch the remaining water. When the refrigerator is defrosted, thoroughly dry the inside.

⚠ WARNING: Do not speed up the defrosting process by removing the ice layer with force or sharp objects or by using a hairdryer.

Storage

If you do not expect to use your refrigerator for a longer period, it is important to thoroughly empty, defrost and clean the complete refrigerator. Then install the winter cover the vents, to protect your refrigerator during storage.

Note: To prevent odours and mould in the refrigerator, keep all doors open during the storage.

Rotate the hook at door lock 45 degrees and lock it in place by using the strike plate.

⚠ WARNING: Make sure the gas taps of the gas bottle are closed during storage.

⚠ WARNING: Water through the vents may damage your refrigerator. Therefore install winter covers before washing your vehicle.

Disposal

Your refrigerator has been designed and manufactured with high quality materials and components, which can be recycled and reused. The cooling system contains ammonia as the coolant and ozone friendly

cyclopentane as the blowing agent in the foam. The refrigerators are free of any CFCs / HCFCs and HFCs.

When your refrigerator has reached its end of life, dispose the product according to the local rules. Do not dispose the refrigerator with normal household waste. The correct disposal of your old product will help prevent potential, negative consequences to the environment and human health.

Questions?

If you require further information or have any questions about your refrigerator, please visit our website www.thetford-europe.com. If you still have questions, contact the Customer Service Department in your country or your holiday location.

For correct and efficient support, please ensure all relevant product type information is available.

THETFORD REFRIGERATOR TROUBLESHOOTING

Troubleshooting

Some problems are indicated through blinking lights on your control panel. First read the instructions below. If these will not solve the problem, contact your dealer or a Thetford Service Centre.

I just replaced the batteries, but the 'batteries empty' symbol is already blinking. What is wrong? Check if you have used only new 1.5 V AA / LR6 batteries. Rechargeable batteries for this function do not work.

Problem	Actions you can take
The refrigerator does not work on 230V	<ul style="list-style-type: none"> - Check if the mains is available. - Try to run the refrigerator on another power source.
The refrigerator does not work on 12 V	<ul style="list-style-type: none"> - Check if the 12 V fuse in the fuse box of your motorhome or car is till operational. - Make sure the engine is running. - Try to run the refrigerator on another power source.
The refrigerator does not work on gas	<ul style="list-style-type: none"> - Check if the gas bottle is empty - Check if the valve of the gas bottle and all shut-off valves are open. - Switch the refrigerator off and on again. - Try to run the refrigerator on another power source.

FAQ

What can I do, when the refrigerator does not start? Check if you switched on the refrigerator according to the instructions, if the vehicle stands level or if there is an available energy source to start the refrigerator with. If none of this is the case, please contact your dealer or a Thetford Service Centre.

The refrigerator does not cool sufficiently, what can I do? Check if the vents aren't covered or blocked from the outside, if the refrigerator stands level, if the highest cooling setting of the refrigerator is selected, if the door of the refrigerator still closes properly or if there is not too much ice on the cooling fins. If none of this is the case, please contact your dealer or a Thetford Service Centre.

All lights on the control panel are blinking, what should I do? Please contact your dealer or a Thetford Service Centre.

No winter cover is supplied with my refrigerator, is this correct? The winter cover is an accessory for your refrigerator, which you can purchase at your dealer.

Spare Parts

Original Thetford spare parts are available through your own dealer or an authorised Thetford Service Centre.

Warranty

Thetford BV offers the end users of its products a three year guarantee. In the case of malfunction within the warranty period, Thetford will replace or repair the product at its discretion. In this case, the costs of replacement, labour costs for the replacement of defective components and/or the cost of the parts themselves will be paid by Thetford.

1. To make a claim under this guarantee, the user must take the product to his dealer or an authorised Thetford Service Centre (www.thetford-europe.com). The claim will be assessed there.
2. Components replaced during repair under guarantee become the property of Thetford.
3. This warranty does not prejudice current consumer protection laws.
4. This warranty is not valid in the case of products that are for, or are used from, commercial purposes.
5. Guarantee claims falling into one of the following categories will not be accepted:
 - the product has been improperly used, or the instructions in the manual have not been followed;
 - the product has not been installed in accordance with the instructions;
 - the product has been repaired by unauthorised Thetford Service Centre;
 - the product code or serial ID has been changed;
 - the product has been damaged by circumstances outside the normal use of the product.
6. The guarantee is only valid for Thetford refrigerators that are built in a caravan or camper van.

Thetford is not liable for any loss and/or damage caused directly or indirectly by the use of the refrigerator.

Dometic absorption refrigerator

Challenger and Eccles SE, Conqueror, Elite and Cameo

Guide to these operating instructions

Before you start using the refrigerator, please read the operating instructions carefully.

These instructions provide you with the necessary guidance for the proper use of your refrigerator. Observe in particular the safety instructions. Observation of the instructions and handling recommendations is important for dealing with the refrigerator safely and for protecting you from injury and the refrigerator from damage. You must understand what you have read before you carry out a task.

Keep these instructions in a safe place close to the refrigerator so they may be referred to at any time.

Copyright protection

The information, texts and illustrations in these instructions are copyright protected and are subject to industrial property rights.

No part of these instructions may be reproduced, copied or utilised in any other way without written authorisation by Dometic GmbH, Siegen.

Warranty

Warranty arrangements are in accordance with EC Directive 44/1999/CE and the normal conditions applicable for the country concerned.

For warranty or other maintenance, please contact our customer services department.

Any damage due to improper use is not covered by the warranty. The warranty does not cover any modifications to the appliance or the use of non-original Dometic parts. The warranty does not apply if the installation and operating instructions are not adhered to and no liability shall be entertained.

DOMETIC REFRIGERATOR

Limitation of liability

All information and guidance in these operating instructions were prepared after taking into consideration the applicable standards and regulations as well as the current state of the art. Dometic reserves the right to make changes at any time which are deemed to be in the interest of improving the product and safety.

Dometic will assume no liability for damage in the case of :

- Non-observation of the operating instructions
- Application not in accordance with the regulations or provisions
- Use of non-original spare parts
- Modifications and interferences to the appliance
- Effect of environmental influences, such as
 - temperature fluctuations
 - humidity

Customer services

Dometic offers a pan-European customer service network. Find your authorised customer service centre by calling the phone number indicated in the EuroService Network book, EuroService Network - which accompanies every refrigerator. You can also obtain the address information of the nearest customer service from www.dometic.com. When contacting Dometic Customer Services, please state the model, product number and serial number together with the MLC code, if applicable. You will find this information on the rating plate inside the refrigerator. We recommend that you note this data in the field provided on the front page of this operation manual.

Spare parts

Parts can be ordered throughout Europe from our customer services. Always give the model and product number when you contact the customer service! You will find this information on the rating plate inside the refrigerator.

Environmental notice

Refrigerators manufactured by Dometic GmbH are free of CFC/HCFC and HFC. Ammonia (a

natural compound of hydrogen and nitrogen) is used in the cooling unit as a coolant. Non-ozone-hazardous cyclopentane is used as a propellant for manufacturing PU foam insulation.

In order to ensure that the recyclable packaging materials are re-used, they should be sent to the customary local collection system.

The appliance should be transferred to a suitable waste disposal company that will ensure re-use of the recyclable components and proper disposal of the rest. For eco-friendly draining of the coolant from all absorber refrigeration units, a suitable disposal plant should be used.

Energy-saving tips

- At an average ambient temperature of 25°C, it is sufficient to operate the refrigerator at middle thermostat setting.
- Where possible, always store precooled products.
- Do not expose the refrigerator to direct sunlight.
- Ensure that air circulation of the cooling unit is not obstructed.
- Defrosting at regular intervals saves energy (see "Defrosting"). Open the refrigerator door only for a short period of time when removing products.
- Run the refrigerator for about 12 hours before filling it.

Safety instructions

Application according to regulations

This refrigerator is designed for installation in recreation vehicles such as caravans or motorhomes. The appliance has been type approval tested for this application in accordance with the EC Gas Directive.

The refrigerator is to be used solely for storing foodstuffs.

⚠ WARNING: Do not lift the coupling head by hand when hitching the caravan to the car. Always raise and lower the coupling head by winding the handle on the jockey wheel up and down.

User's responsibility

Anyone operating the refrigerator must be familiar with the safe handling and understand the advice in these operating instructions. Children may only operate the appliance, if they have been made aware of how to operate the refrigerator safely and the dangers attending incorrect operation.

Protection of children when disposing of the equipment

⚠ WARNING: When disposing of the refrigerator, detach all refrigerator doors and leave the storage racks in the refrigerator. In this way inadvertent entrapment and suffocation is prevented.

Working upon and checking the refrigerator

⚠ WARNING: Work on gas equipment, exhaust system and electrical facilities must be carried out by authorised personnel only. Substantial damage to property and / or injury to persons can arise through unprofessional procedures.

⚠ WARNING: Never use an unshielded flame to check gas bearing parts and pipes for leakage! There is a danger of fire or explosion.

⚠ WARNING: Never open the absorber cooling unit! It is under high pressure. There is a danger of injury.

Information on coolant

Ammonia is used as a coolant. This is a natural compound also used in household cleaning agents (1 litre of Salmiak cleaner contains up to 200g of ammonia - about twice as much as is used in the refrigerator). Sodium chromate is used for corrosion protection (1.8% by weight of the solvent).

In the event of leakage (easily identifiable from the strong odour), proceed as follows:

- Switch off the appliance.
- Air the room thoroughly.
- Inform authorised customer services.

Note: For your safety it was ascertained in an expert's report that no impairment of health exists when the coolant is discharged.

Operating the refrigerator with gas

It is imperative that the operating pressure corresponds to the data specified on the rating plate of the appliance. Compare the operating pressure of the rating plate with the data specified on the pressure reducing valve of the liquid gas cylinder.

⚠ WARNING: Operating the appliance with gas is not permitted

- At petrol stations
- On ferry boats
- While transporting the caravan / motorhome by a transporter or breakdown vehicle.

There is danger of fire!

Leave the equipment switched off.

DOMETIC REFRIGERATOR

Safety instructions when storing foodstuffs

Instructions for storing food in a refrigerator:

No refrigerator of any kind can improve the quality of the food; refrigerators can only maintain the food's quality for a short duration as from the time of storing it.

Please observe the following particular conditions for storing food in a refrigerator that is built into a vehicle:

- A change in the climatic conditions such as temperature fluctuations
- High temperatures inside the vehicle when it is closed and parked in direct sunlight (temperatures are possible up to 50°C)
- Use of the refrigerator during travel with the power supply of 12V DC
- A refrigerator built in behind a window and exposed to direct sunlight
- Storing the products too soon, i.e. shortly after starting up the appliance for use

Under these particular conditions the refrigerator cannot guarantee reaching the temperature needed for perishables.

Perishables include all products with a stipulated use-by date and a minimum storage temperature of +4°C or less, especially for meat, poultry, fish, sausages, pre-packed foods.

- Pack raw and cooked foods separately (e.g. in containers, aluminium foil, etc.).
- Only remove the outside packaging of single packs if all the necessary information, e.g. the use-by date, can also be read on the single packs.
- Do not leave cooled goods outside the refrigerator for too long.
- Place the foods with the next use-by date at the front, accordingly.
- Pack away any left-over food and eat at the first opportunity.

- Wash your hands before and after handling any food.
- Regularly clean the inside of the refrigerator.

Please observe the instructions and information regarding the use-by date on the outside packaging of the food.

Please observe section "Cleaning" of this instruction.

Refrigerator rating plate

The rating plate is to be found on the inside of the refrigerator. It contains all important details of the refrigerator. You can read off from this the model identification, the product number and the serial number. You will need these details whenever you contact the customer service centre or when ordering spare parts.

Dometic			
TYPE	C 40/110	CLIMATE CLASS	SN
MOD. NO.	RMS 8400 1	PROD. NO.	00921084272 2
		DO	SER. NO.
			99900165 3
BRUTTOINHALT TOTAL CAP. VOLUME BRUT	80 l 85 l	VERDAMPFERFACH FREEZER COMP. VOLUME COMPT BT	8 0 0
		NUTZINHALT USEFUL CAP. VOLUME NET	77 l 82 l
~ 230-240V / 125 W 12 V / 120 W	LPG	Q _n : 0.252 kW (M5) h: 18.3 g/h	
4		5	13+ 28-30/37 130/P 28-30 13P 37 mbar
CE 0069 BLS214	G30, G31	p = 30/37 mbar	
ABSORPTION	NH ₃ = 115 g	Ne ₂ CrO ₂ = 7.0 g	p max = 35 bar
	37	0065	021854
			2 660
FKW, FCKW FREI / CFC, HCFC FREE		MADE IN GERMANY	
		00057384562	

1 - Model Number

2 - Product Number

3 - Serial Number

4 - Electrical rating details

5 - Gas pressure

The cooling unit's performance is influenced by ambient temperatures. Please select the medium setting for ambient temperatures between +15°C and +25°C (refer to Setting of cooling compartment temperature.) The unit operates within its optimum performance range.

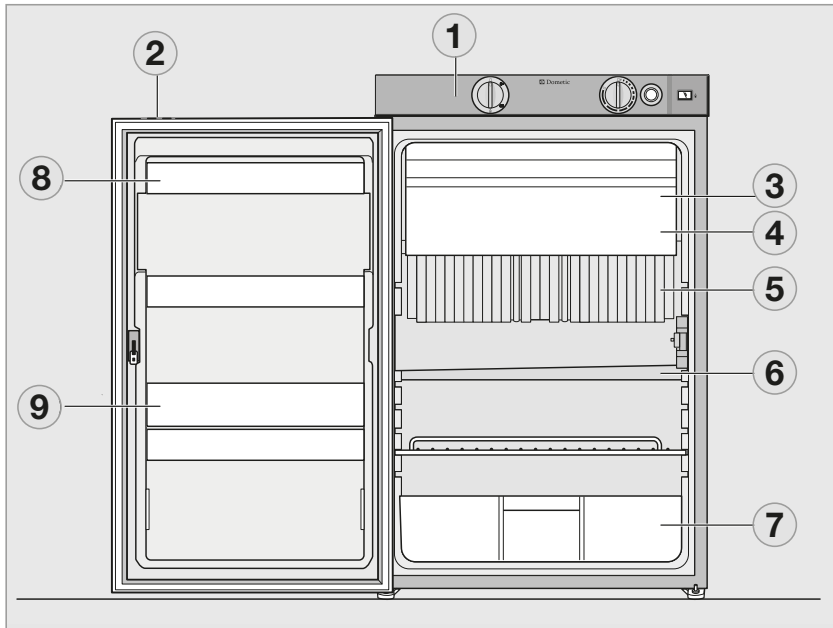
Dometic refrigerators work according to the absorption principle. For physical reasons, an absorption system responds slowly to

changes made by the thermostat controller, by loss of cooling energy through opening the door storing food. The devices meet the cooling performance requirements of the Climatic Clas SN acc. to EN/ISO 7371 in the temperature range of +10°C to +32°C ambient temperature.

For temperatures below +10°C, winter covers should be installed. For ambient temperatures exceeding +32°C for a longer period of time, it is recommended installing Dometic additional fan (item no. 241 2985 - 00).

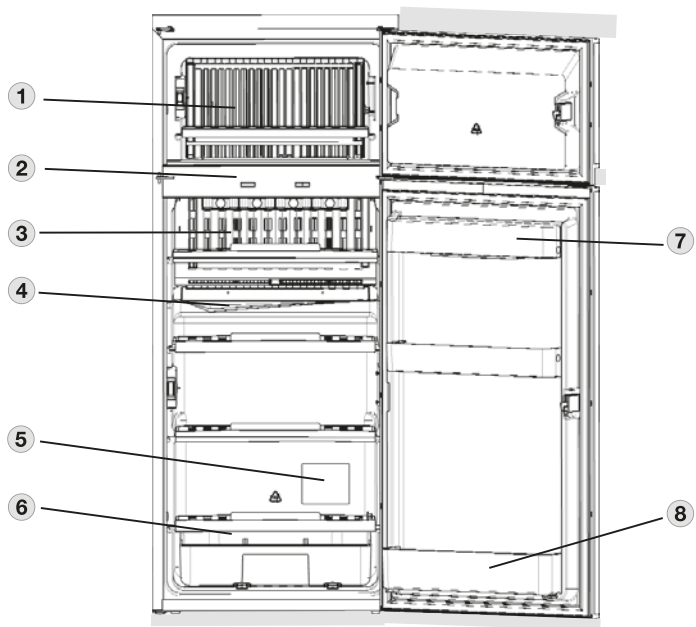
DOMETIC REFRIGERATOR

Description of refrigerator



(Appearance is model specific)

- 1 - Operating controls
- 2 - Door locking button
- 3 - Freezer compartment (removable)
- 4 - Insertable grid shelf (available as option, to be used when freezer compartment is removed)
- 5 - Post-evaporator for cooling compartment
- 6 - Condensation water drain channel
- 7 - Vegetable bin
- 8 - Upper door shelf with flap, egg shelf available as option may be inserted
- 9 - Lower door shelf with bottle holders



- 1 - Freezer compartment
- 2 - Operating controls
- 3 - Post evaporator for cooling compartment
- 4 - Condensation water drain channel
- 5 - Data plate
- 6 - Vegetable bin
- 7 - Upper door shelf with flap, egg shelf available as option may be inserted.
- 8 - Lower door shelf with bottle holders

DOMETIC REFRIGERATOR

Refrigerator operation

The refrigerator is equipped to operate on three power modes:

- Mains voltage (230V AC)
- Direct-current voltage (12V DC)
- Gas (liquid gas propane/butane)

Select the desired power mode by the energy selector switch (battery igniter type models) or the MODE button (MES, AES). Appliances with automatic energy selection (AES) are additionally provided with “automatic mode” function. The AES system automatically selects the best energy source for each particular situation.

Cleaning

Before starting up the refrigerator, it is recommended that you clean it inside and repeat this at regular intervals.

Use a soft cloth and lukewarm water with a mild detergent. Then wipe out the appliance with clean water and dry thoroughly.

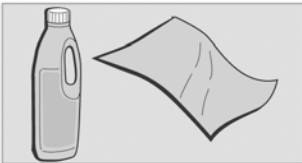


Fig. 6

To avoid material alterations, do not use soap or hard, abrasive or soda-based cleaning agents.

Do not allow the door seal to come into contact with oil or grease.

Maintenance

- In compliance with the applicable regulations, please note that the gas unit and the connected ventilation ducts must be checked by authorised technical personnel after first use and after every other year for compliance with the European Standard EN 1949. A test certificate has to be issued. It is the user’s responsibility to arrange this test.

- The gas burner must be inspected and cleaned as necessary at least once a year. When using liquefied petroleum gas (tank or refill cylinders) the maintenance interval is reduced to half-yearly or quarterly. Keep the evidence of maintenance work carried out on your refrigerator.

- Work on gas and electrical equipment shall be carried out by qualified personnel only.

It is recommended that this is carried out by an authorised customer services department.

We recommend maintenance following an extended shutdown of the vehicle. Please contact our customer services.

Manual energy selection / automatic ignition (RM 8xx1) MES (fridge models)

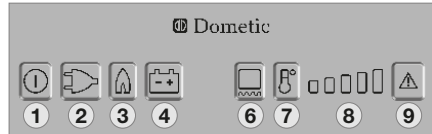


Fig. 7

- 1 - Power ON/OFF switch
- 2 - Energy selector button 230V ~
- 3 - Energy selector button GAS
- 4 - Energy selector button 12V =
- 6 - Temperature level selection
- 7 - Temperature level display
- 8 - Indicator LED failure / Reset button
GAS FAILURE

Switching ON/OFF

- Switch ON by pressing button (1), 2s
- Switch OFF by pressing button (1), > 2s

230V AC operation

- Select “Mains voltage” by pressing button (2)
- Set temperature step by pressing button (6)

12V DC operation (vehicle's battery)

- Select "Battery voltage" by pressing button (4)
- Set temperature step by pressing button (6)

Gas operation

- Select "Gas" by pressing button (3)
- Set temperature step by pressing button (6)

RM 8XX1 MODELS MES appliances (manual energy selection)

Electrical operation

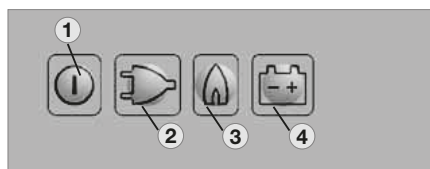




Fig. 16

To start the refrigerator, press button (1) for 2 seconds.

The refrigerator starts with the last selected type of energy.

230V operation :  Press button (2) :

12V operation :  Press button (4) :

Gas operation

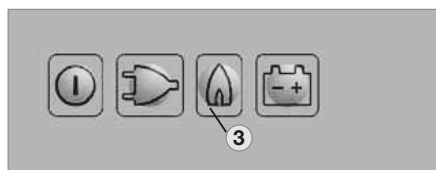



Fig. 17

Gas operation :  Press button (3) :

The ignition process is activated automatically by means of an automatic igniter.

Note: The flame extinguishes after reaching the preset cooling compartment temperature and ignites again if the cooling compartment temperature increases again. If the flame is not lit after the first ignition attempt, the automatic igniter repeats the ignition twice (duration 30 s) at time intervals of 2 minutes. If the flame is not lit afterwards, a fault is indicated.

Setting of cooling compartment temperature

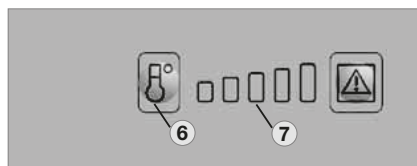


Fig. 18

Select the desired cooling compartment temperature by pressing button (6) .

The LED display (7) of the selected temperature setting is illuminated.

The scale starts with MIN position at the left LED position (small bar = highest temperature) and climbs up to MAX position at the right LED position (large bar = lowest temperature).

Note: The temperature levels do not relate to absolute temperature values.

Additional features

- The brightness of the display reduces after a few seconds if no other buttons are pressed. The indicator lights again if a button is pressed. Press the button again to activate the required function.
- Failures are indicated by flashing of the failure indicator LED.
- Should the door be kept open for too long (more than 2 minutes), an acoustic signal is initiated (pulsing whistle tone).
- Should the electronic control detect any failure, an acoustic signal will sound (pulsing whistle tone). At the same time the display starts flashing (for trouble-shooting, please refer to page 151).

DOMETIC REFRIGERATOR

Gas operation with internal batteries (optional)

An optional battery compartment in the electronics case for internal (self-contained) power supply of the electronics is available for the model variants RM 8xx1 and RM 8xx5 (appliances with electronics).



Fig. 21

Load the battery compartment with batteries (8 x AA 1.5 V) before operating the refrigerator.

All operating modes can be selected while the on-board 12 V DC power supply is active. The internal voltage is disconnected.

If the on-board 12 V DC power supply is not present or there is an interruption of the mains power supply during operation, the electronics automatically switch to the internal (battery) power supply. The refrigerator can now only be operated in the gas mode.

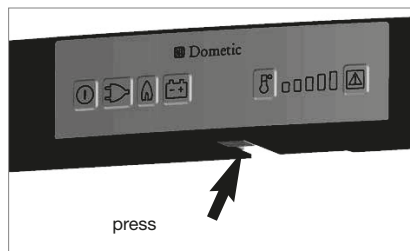
All LED indicators except the GAS LED are not lit during operation with internal batteries. The GAS LED flashes every 15 seconds.

If a button is pressed, the temperature level LEDs (7) also light.

If the battery voltage is too low, an acoustic signal (whistle tone) sounds every 15 seconds. Then replace the batteries in the battery compartment.

Inserting / changing the batteries

- Switch off the refrigerator, as described in section 'Shutting of the refrigerator'



Opening battery compartment

Fig. 22

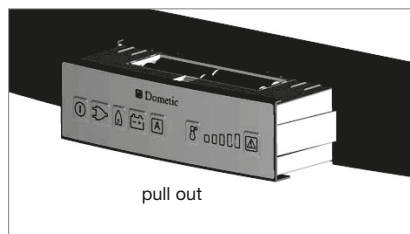


Fig. 23

Note: Batteries (8 x AA 1.5V) are not included!

⚠ WARNING:

- Observe the correct polarity !
- Do not connect non-rechargeable batteries to a charger.
- Remove rechargeable batteries from the battery compartment before charging.
- Avoid short circuits on the contacts in the battery compartment!
- Remove discharged batteries.
- Remove the batteries from the battery compartment if the refrigerator will not be used for a long time.
- Do not mix different types of batteries.

Explanation of operating controls

The control panel buttons are not accessible when the refrigerator door is closed. Open the bottom door to reach the operating buttons.

Depending on the door opening direction, there are two LEDs on the left or right edge of the control panel. The outer LED (1) indicates that the refrigerator is operational (blue). The other LED (2) lights red in the event of a fault.



Fig. 4

Refrigerators for self-contained (gas) operation contain two battery compartments in the control panel which are located on the left and right next to the button bar.



Fig. 5



Fig. 6

Manual energy selection / automatic ignition (RMD 8xx1) MES



Fig. 7

- 1 - Power ON/OFF switch
- 2 - Energy selector button 230V ~
- 3 - Energy selector button GAS
- 4 - Energy selector button 12V =
- 6 - Frameheating
- 7 - Temperature level selection

8 - Temperature level display

9 - Indicator LED failure / Reset button
GAS FAILURE

Switching ON/OFF

- Switch ON by pressing button (1), 2s
- Switch OFF by pressing button (1), > 2s

230V AC operation

- Select "Mains voltage" by pressing button (2)
- Set temperature step by pressing button (7)

12V DC operation (vehicle's battery)

- Select "Battery voltage" by pressing button (4)
- Set temperature step by pressing button (7)

Gas operation

- Select "Gas" by pressing button (3)
- Set temperature step by pressing button (7)

RMD 85x1 models MES-appliances (manual energy selection)

Electrical operation

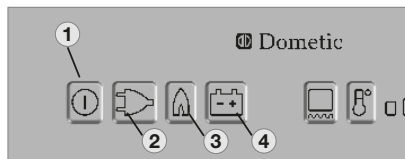



Fig. 9

To start the refrigerator, press button (1) for 2 seconds.

The refrigerator starts with the last selected type of energy.

230V operation :  Press button (2) :

12V operation :  Press button (4) :

DOMETIC REFRIGERATOR

Gas operation

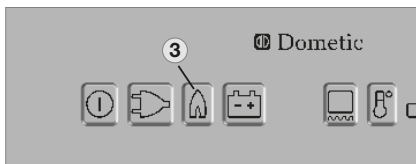



Fig. 10

Gas operation :

Press button (3) : 

The ignition process is activated automatically by means of an automatic igniter.

Note: The flame extinguishes after reaching the preset cooling compartment temperature and ignites again if the cooling compartment temperature increases again. If the flame is not lit after the first ignition attempt, the automatic igniter repeats the ignition twice (duration 30 s) at time intervals of 2 minutes. If the flame is not lit afterwards, a fault is indicated.

Setting of cooling compartment temperature

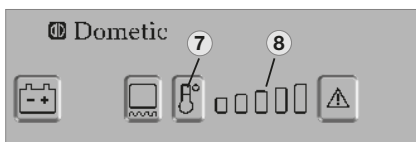


Fig. 11

Select the desired cooling compartment temperature by pressing button (7) .

The LED display (8) of the selected temperaturesetting is illuminated.

The scale starts with MIN position at the left LED position (small bar = highest temperature) and climbs up to MAX position at the right LED position (large bar = lowest temperature).

Note: The temperature levels do not relate to absolute temperature values.

Additional features

- The brightness of the display reduces after a few seconds if no other buttons are pressed. The indicator lights again if a button is pressed. Press the button again to activate the required function.
- Failures are indicated by flashing of the failure indicator LED.
- Should the door be kept open for too long (more than 2 minutes), an acoustic signal is initiated (pulsing whistle tone).
- Should the electronic control detect any failure, an acoustic signal will sound (pulsing whistle tone). At the same time the display starts flashing (for trouble-shooting, please refer to page 151).

Gas operation with internal batteries (optional)

An optional battery compartment in the electronics case for internal (self-contained) power supply of the electronics is available for the model variants RMD 85x1 and RMD 85x5 (appliances with electronics).

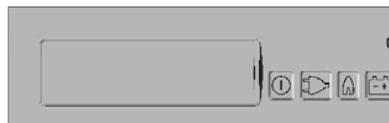


Fig. 14

Load the battery compartment with batteries (8 x AA 1.5 V) before operating the refrigerator.

All operating modes can be selected while the on-board 12 V DC power supply is active. The internal voltage is disconnected.

If the on-board 12 V DC power supply is not present or there is an interruption of the mains power supply during operation, the electronics automatically switch to the internal (battery) power supply. The refrigerator can now only be operated in the gas mode.

All LED indicators except the GAS LED are not lit during operation with internal batteries. The GAS LED flashes every 15 seconds.

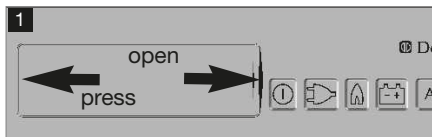
If a button is pressed, the temperature level LEDs (7) also light.

If the battery voltage is too low, an acoustic signal (whistle tone) sounds every 15 seconds.

Then replace the batteries in the battery compartment.

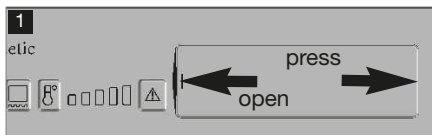
Inserting / changing the batteries

Switch off the refrigerator, as described in section 4.14 Shutting of the refrigerator.



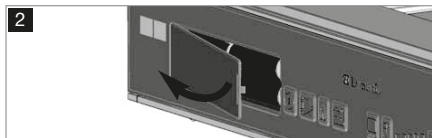
Opening left battery compartment

Fig. 15



Opening right battery compartment

Fig. 16



Note: Batteries (8 x AA 1.5V) are not included!

⚠ WARNING:

- Observe the correct polarity!
- Do not connect non-rechargeable batteries to a charger.
- Remove rechargeable batteries from the battery compartment before charging.
- Avoid short circuits on the contacts in the battery compartment!
- Remove discharged batteries.
- Remove the batteries from the battery compartment if the refrigerator will not be used for a long time.
- Do not mix different types of batteries.

Frame heating (fridge freezer models only)

All fridge freezer models are equipped with a frame heating (12VDC/3,5W) around the freezer compartment. During summer months with high temperatures and humidity the metal frame may have water droplets forming. To evaporate these droplets switch on the frame heating with button (6).

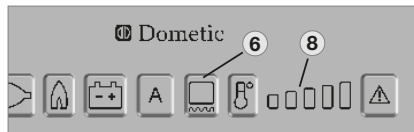


Fig. 18

The operating time of the frame heater can be set to 2 hours, 5 hours or continuous operation. After selecting the operating time using the button (6), the temperature level indicator (8) is extinguished for a short time to show the set operating time for a few seconds. The display then returns to the temperature level indicator.

Operating time: 2 hours

Press button (6) once Display



Operating time: 5 hours

Press button (6) twice Display



Permanent operation

Press button (6) three times Display



DOMETIC REFRIGERATOR

⚠ WARNING: In order to prevent discharge of the onboard battery, change the frame heater from continuous operation to another operating time or switch it off.

Note: The frame heater is active for 30 minutes after switching on and then switches itself off and on again at time intervals of 5 minutes.

Door locking

⚠ WARNING: As a basic rule, shut and lock the refrigerator before you start your journey!

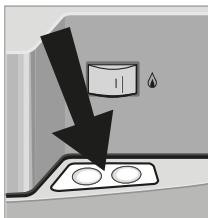


Fig. 24



Fig. 25

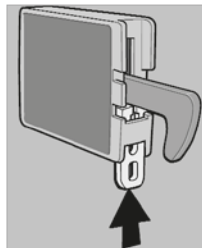
Open the door by pressing the locking button and pull open (see Fig. 24).

Shut the door again by pushing it to close. The snapping into the lock can be heard.

While the vehicle is parked, the locking hook may be fixed to facilitate opening of the door (Fig. 26-27).

Fastening and releasing the door lock hook when parking the vehicle

If the vehicle is parked for a longer period of time, the locking hook may be clamped by means of a lockbar. The door may now be opened by just pulling it without need of pressing the locking button.



Fastening

Fig. 26

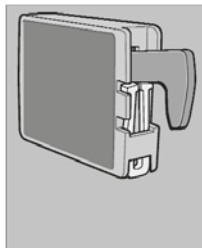
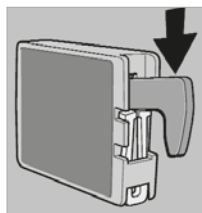


Fig. 27



Releasing

Fig. 28

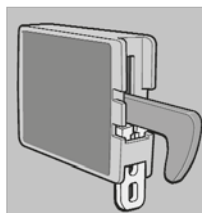


Fig. 29

Lighting

The interior lighting is controlled using a door contact. Should the door be kept open more than 2 minutes, an acoustic signal is initiated (pulsing whistle tone). **(except for models with battery igniter).**

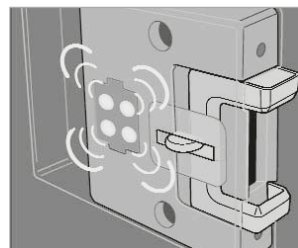


Fig. 30

Note: Please contact the authorized Dometic Service if a failure occurs.

Positioning the storage racks

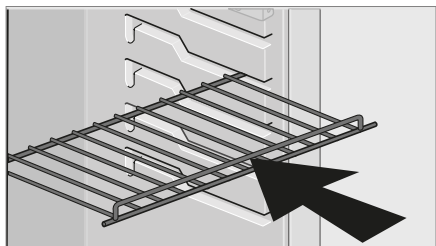


Fig. 31

The storage racks may be pulled out by smoothly lifting them and may be positioned as desired.

Removable freezer compartment

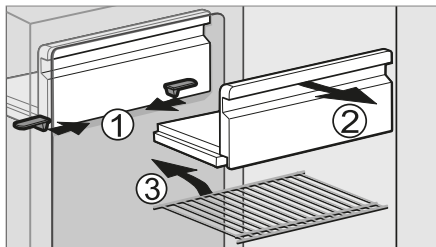


Fig. 32

To enlarge the cooling compartment, just remove the freezer compartment.

1. Unlock the freezer compartment on both sides.
2. Pull the freezer compartment out. Store the freezer compartment safely in order to prevent damage

Note: Once the freezer compartment is removed, an additional storage rack (3.) may be installed. The storage rack is a piece of extra equipment and may be obtained by Dometic.

Winter operation

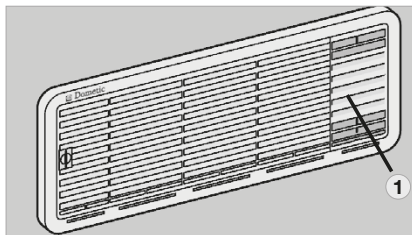


Fig. 35

In winter, check that the ventilation grilles and the exhaust duct system (1) have not been blocked by snow, leaves, etc.

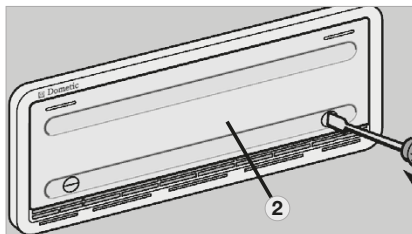


Fig. 36

When the outside temperature falls below +10°C, the winter covers should be fitted. This protects the unit from excessively cold air which could have adverse effects on the performance of the unit.

Covers may be supplied as part of the specification of your caravan or alternatively are available through most Swift Group Dealers.

Note: You should also attach the winter covers if the vehicle is taken out of service for a longer period of time or while it is being cleaned from the outside.

Winter operation (fridge freezer models)

In winter, check that the ventilation grilles and the exhaust duct system (1) have not been blocked by snow, leaves, etc.

Note: Winter covers are not supplied as standard on most models.

DOMETIC REFRIGERATOR

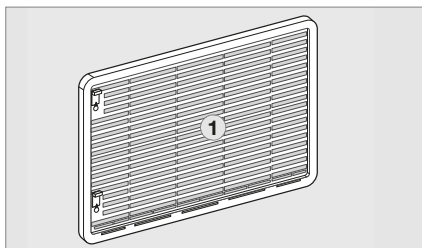


Fig. 32

When the outside temperature falls below +10°C, the winter cover (2) should be fitted. This protects the unit from excessively cold air which could have adverse effects on the performance of the unit.

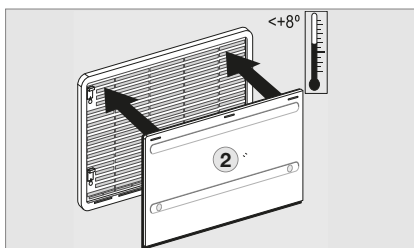


Fig. 33

You should also attach the winter covers if the vehicle is taken out of service for a longer period of time or while it is being cleaned from the outside.

Storing food and making ice cubes

Storing products in the cooling compartment

- Switch the refrigerator on approx. 12 hours before filling it.
- Always store pre-cooled foods in the refrigerator. Make sure that the food is well cooled when it is bought and also when transporting it. Use insulated cooling bags.
- Open the refrigerator door only for a short period of time when removing products.

- Products must be packed - best of all in closed containers, wrapped in aluminium foil or similar - and stored separately from each other, in order to prevent drying out or odours.
- Allow foods that have been warmed up to cool down before storing.
- Avoid storing products in the refrigerator that could emit volatile flammable gases.
- Do not overfill the storage grids and compartments to prevent obstructing the internal air circulation.
- Maintain a clearance of approx. 5 - 10 mm between chilled products and post-evaporator ("cooling fins").
- Do not expose the refrigerator to direct sunlight. Please bear in mind that the temperature inside a closed vehicle increases sharply if exposed to sunlight and that this can reduce the efficiency of the refrigerator.
- Ensure that air circulation of the cooling unit is not obstructed. Keep the ventilation grilles free from obstructions.

Storing products in the freezer compartment

- Do not keep carbonated drinks in the freezer.
- The freezer compartment is suitable for making ice cubes and for short-term storage of frozen food. It is not suitable as a means of freezing foods.

When ambient temperatures are lower than +10°C and the refrigerator is exposed to these temperatures for extended periods of time, an even regulation of freezer temperature cannot be guaranteed for system related reasons. This can cause the temperature in the freezer to rise and the stored goods to melt.

Refrigerator compartments

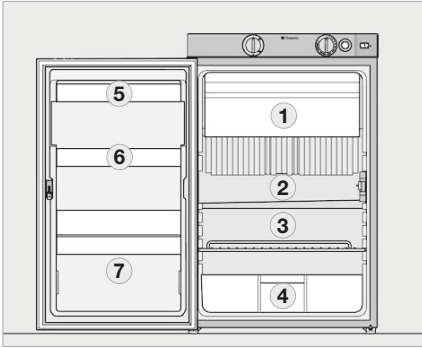


Fig. 37

- 1 - Freezer compartment:**
already frozen food (deep-frozen food)
- 2 - Middle compartment:**
Dairy products, convenience food
- 3 - Bottom compartment:**
Meat, fish, food for defrosting
- 4 - Vegetable compartment:**
Salads, vegetables, fruit
- 5 - Top door shelf:**
Eggs, butter
- 6 - Middle door shelf:**
Cans, dressings, ketchup, jam
- 7 - Bottom door shelf (drinks compartment):**
Drinks in bottles or bags

Positioning the storage racks

The storage racks may be pulled out by loosening the two locking devices (1) underneath. For loosening pull the slider to the middle, for fastening pull them sideways.

Two of the storage racks are secured. In this way inadvertent entrapment and suffocation of children is prevented, if the storage racks are removed. To protect children it must be avoided to create space for children in the cooling compartment.

⚠ WARNING: Do not remove these storage racks. Thus children have no space to be entrapped in the refrigerator.

If it is necessary to remove these storage racks (i.e. for cleaning) loosen the locking pins (2) at first as shown, by means of a suitable screw driver.

Put in place the locking pins after removing the storage racks.

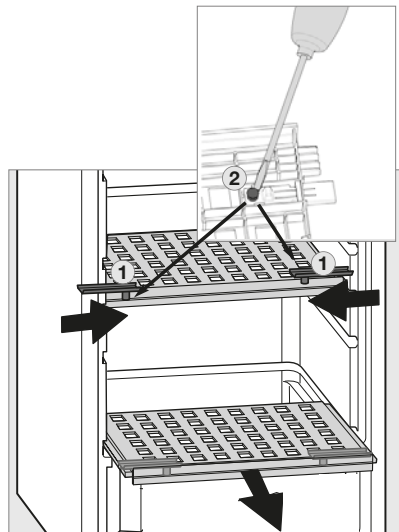


Fig. 26

DOMETIC REFRIGERATOR

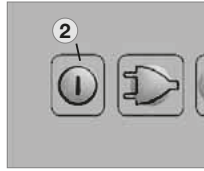
Shutting off the refrigerator

Fig. 41

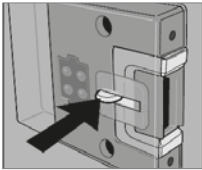


Fig. 42

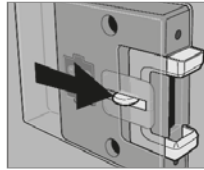


Fig. 43

- For battery igniter models, set energy selector switch (1) to position "OFF". The appliance is switched off (Fig. 40).
- Switch off MES and AES models by pressing button (2). Keep button (2) pressed for 3 seconds. The display disappears and the appliance is fully switched off (Fig. 40).
- Release the locking mechanism of the door lock by pushing it and shift it to the front. If the door is shut in this position, a small gap is nevertheless kept open to prevent formation of mildew.
- If the refrigerator is to be taken out of service for an extended period of time, close the onboard shut-off valve and the cylinder valve.

Troubleshooting

Failure: The refrigerator does not cool sufficiently.

Possible cause	Action you can take
Inadequate ventilation to the unit	Check that the ventilation grilles are not covered
Thermostat setting is too low	Set thermostat to a higher level
The condenser is heavily frosted	Check that the refrigerator door closes properly
Too much warm food has been stores inside within a short period of time	Allow warm food to cool down before storage
The appliance has been running for only a short period of time	Check whether the cooling compartment works after approx 4-5 hours
Ambient temperatures too high	Regularly remove ventilation grilles.

Failure: The refrigerator does not cool in gas operation mode.

Possible cause	Action you can take
Gas cylinder empty	Change gas cylinder
Is the upstream shut-off device open?	Open shut-off device
Air in the gas pipe?	Switch off the appliance and start again. Repeat this procedure 3-4 times, if necessary.

Failure: The refrigerator does not cool in 12 V operation.

Possible cause	Action you can take
On-board fuse defective	Fit new fuse
On-board battery displaced	Check battery, charge it
Engine not running	Start engine
Heating element defective (please refer to failure indication)	Please inform the Dometic Customer Services.

DOMETIC REFRIGERATOR

Failure: The refrigerator does not cool in 230 V operation.

Possible cause	Action you can take
On-board fuse defective	Fit new fuse
Vehicle not connected to mains supply voltage	Make a connection to a mains power supply
AES: Gas operation despite connection to the mains supply voltage?	Appliance switches to gas operation due to insufficient mains supply voltage (automatically switches back to 230 V operation)
Heating element defective (please refer to failure indication)	Please inform Dometic Customer Services

Information on failure display and trouble-shooting

- Refrigerators with an electronics system (MES, AES) indicate the occurrence of a malfunction by the LED or display flashing.
- If a malfunction occurs, the indicator LED “Failure” (8) flashes simultaneously. In the case of AES models an acoustic alarm sounds.

Before notifying the authorised Service Center, please check whether:

- the instructions in section “Operating the refrigerator” have been observed.
- the refrigerator stands level.
- it is possible to operate the refrigerator with any available power source.

Status indicators



MES

Fig. 51

- 1 - Button ON / OFF
- 2 - Energy selector switch 230 V AC
- 3 - Energy selector switch GAS
- 4 - Energy selector switch 12V DC
- 6 - temperature level button
- 7 - temperature level display
- 8 - fault LED / GAS FAULT reset button

Operation with on-board 12 v power supply

Indicator	Fault	Remedy
(2) and (8) flashing and acoustic signal 20s	230 V mode: "230V" not available or voltage too low	Check mains power connection, mains voltage, fuse
(4) and (8) flashing and acoustic signal 20s	12 V mode: "12V" not available or voltage too low	Check 12V connection, on-board battery, fuse
(3) and (8) flashing and acoustic signal 20s	Gas mode: Flame not ignited	Check gas supply (gas bottle, gas valve) Press the (8) button after clearing the fault
Acoustic signal, 15s at two minute intervals	Interior lighting is switched on	Close door, check door contact
(2) and (7) flashing and acoustic signal 20s	230 V mode: 230V heating element defective	Arrange replacement of 230V heating element, contact Customer Service
(4) and (7) flashing and acoustic signal 20s	12 V mode: 12V heating element defective	Arrange replacement of 12V heating element, contact Customer Service
(7) flashing and acoustic signal 20s	Temperature sensor without contact or defective	Contact Customer Service
(3) and (7) flashing and acoustic signal 20s	Burner defective or cooling unit defective	Check burner, burner nozzles, if necessary contact Customer Service and arrange replacement

COOKER OPERATION

Operation with batteries (internal power supply)

Indicator	Fault	Remedy
(3) and (8) flashing brightly	Flame not ignited	Check gas supply (gas bottle, gas valve) Press the (8) button after clearing the fault
(3) and (7) flashing brightly	Burner defective or cooling unit defective	Check burner, burner nozzles, if necessary contact Customer Service and arrange replacement
Acoustic signal at 15 second intervals	Undervoltage detection (internal batteries)	Replace batteries
Automatic switching from external to internal power supply does not function (absence of the onboard 12V power supply for the electronics)	Refrigerator does not function, gas operation not possible although the batteries are inserted	Switch off the refrigerator and start again The onboard power supply was interrupted during the starting of the gas operation Note: No automatic switching is performed during the ignition.

Cooker 3 Burner + Hotplate operation

Burner operation

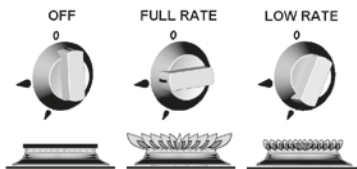


Fig. 1

Important

- Although each burner will support pans from 10 to 22cm, care should be taken not to overload the appliance as performance may be reduced.
- The following pan sizes are the maximum we recommend:- Electric Hotplate:- Ø180mm
Auxiliary Burner:- Ø200mm Semi-Rapid Burner:- 2x Ø200mm or 1x Ø220mm with 1x Ø180mm

- When using small pans the flames should not spread beyond the base of the pan as this will reduce the efficiency of the burner.
- Avoid old or misshapen pans as these may cause instability.
- The lid must be opened fully prior to using the hotplate burners.

Using the Hotplate Gas Burners

1. Ensure gas cylinder/supply is connected and turned on. In the event of a gas smell turn off at gas cylinder/mains and contact supplier.
2. Flame supervision: Each burner is controlled individually and is monitored by a thermocouple probe. In the event of the burner flames being accidentally extinguished, turn off the burner control and do not attempt to re-ignite the burner for at least one minute.

3. To light: Push in the control knob and turn to full rate – see Fig.1. Hold a lighted match or taper to the burner and push the control knob in and hold. It is necessary to hold the knob depressed after the burner has ignited for approximately 10 - 15 seconds, to allow the thermocouple probe to reach temperature, before releasing the knob. Should the flame go out when the knob is released, the procedure should be repeated holding the knob depressed for slightly longer.
4. For models fitted with Spark Ignition the procedure is similar except that the burner can be ignited by depressing the ignition button, which is located on the fascia. If the burner has not lit within 15 seconds the control knob should be released and the burner left for at least 1 minute before a further attempt to ignite the burner.
5. For simmering, turn the knob further anti-clockwise to the low rate position.
6. To turn off: Turn the control knob until the line on the control knob is aligned with the dot on the control panel. Always make sure the control knob is in the off position when you have finished using the hotplate burners.

Operation

Using the Electric Hotplate

Ensure the electricity is switched on.

The hotplate control is numbered from 1 to 6. To turn it on, rotate the knob either clockwise or anti-clockwise to the required position. Position 1 is the coolest setting.

To turn the hotplate off, rotate the knob until the line or pointer on the knob lines up with the zero on the control panel.

The hotplate is a sealed construction and transfers heat through conduction. For maximum efficiency a correctly sized pan with a flat heavy gauge base should be used. Pan size should be the same or slightly larger (up to 1" / 2.5cm oversize).

Before using your hotplate for the first time, we recommend that you prime and then season it.

To prime the Hotplate

Switch on the hotplate for a short period, without a pan, to harden and burn off the coating.

Use a medium to high setting for 3 – 5 minutes. A non toxic smoke may occur during this process. Allow it to cool, then season.

To season the Hotplate


First heat the hotplate for 30 seconds on a medium setting, then switch off. Pour a minimal amount of unsalted vegetable oil onto a clean dry cloth or paper towel, and apply a thin coat of oil to the hotplate surface. Wipe off any excess oil, then heat the hotplate on a medium setting for 1 minute. Occasional seasoning will help to maintain the Hotplate's appearance.

WARNING:

- Glass lids may shatter when heated. Turn off the hotplate and allow it to cool before closing the glass lid.
- Remove all spillage from the surface of the glass lid before opening.
- The glass lid has the tendency to snap shut towards the end of lowering.

This is caused by the travel lock action of the hinges as it is activated.

Make sure all fingers are removed from appliance when closing the lid.

 WARNING: The use of the electric hotplate and gas hobs will generate heat. We recommend, to avoid excess build-up of heat around the cooker area, the window is left opened when cooking to allow for additional ventilation.

COOKER OPERATION

Important

- Depending on specification, your appliance may be fitted with a glass lid shut-off system, which cuts off the power to all hotplate burners (gas and electric) if the lid is closed.
- Ensure the glass lid is in the open and upright position before turning on the hotplate burners.
- Not all models are fitted with the shut-off system.

Operation

WARNING

On separate oven & Grill cookers

- The grill area can get hot when the oven is in use, even if the grill is switched off.
- Care should be taken when removing pans from the grill, i.e. use of oven gloves, and by making use of the removal grill pan handle.
- Care should be taken when using oven as knobs and handle may become hot.

Important

- The grill pan supplied is multi functional, for use in grill or oven.
- The handle design allows removal or insertion whilst the pan is in use.
- Always remove the handle when the pan is in use.
- The grill **MUST** only be used with the door open.

Using the Grill

1. Ensure gas cylinder/supply is connected and turned on. In the event of a gas smell turn off at gas cylinder/mains and contact supplier.
2. To light: Open door, push in the control knob and turn to full rate – see Fig 1 (page 154). Hold a lighted match or taper to the burner and push the control knob in and hold. The burner should ignite and the control knob should be held in for 10 -15 seconds before release.

If the burner goes out, repeat procedure holding control knob for slightly longer.

3. For models fitted with Spark Ignition the procedure is similar except that the burner can be ignited by depressing the ignition button, which is located on the fascia. Ignition must be carried out with the door open, and if the burner has not lit within 15 seconds the control knob should be released and the grill left for at least 1 minute before a further attempt to ignite the burner.
4. **Note:** the grill must only be used with the door open.
5. On first use of the grill, it should be heated for about 20 minutes to eliminate any residual factory lubricants that might impart unpleasant smells to the food being cooked. A non-toxic smoke may occur when using for the first time so open any windows and turn on mechanical ventilators to help remove the smoke.
6. Although the grill does heat up quickly, a few minutes preheat is recommended.
7. Flame Failure Device (FFD): the grill burner is fitted with a flame sensing probe, which will automatically cut off the gas supply in the event of the flame going out. In the event of the burner flames being accidentally extinguished, turn off the burner control and do not attempt to re-ignite the burner for at least one minute.
8. It is normal for the flames on this burner to develop yellow tips as it heats up.
9. A reversible grill pan trivet enables the correct grilling height to be achieved.

Fast Toasting	trivet in high position
Grilling Sausages	trivet in high position
Grilling Steak/Bacon	trivet in high position
Grilling Chops, etc	trivet in low position
Slow Grilling	trivet removed

- To turn off: turn the control knob until the line on the control knob is aligned with the dot on the control panel. Always make sure the control knob is in the off position when you have finished grilling.

Operation

Important

- The appliance is fitted with a cooling system. The cooling fans should automatically switch on a couple of minutes after the grill and/or oven is turned on, and will remain on even after the appliance has been switched off.
- The fans should automatically switch off a few minutes after the appliance has been switched off, when the front of the appliance has cooled sufficiently.
- A constant 12V supply is necessary at all times to ensure the cooling system operates correctly.

Using the Oven

- Ensure gas cylinder/supply is connected and turned on. In the event of a gas smell turn off at gas cylinder/mains and contact supplier.
- To light: Open door, push in the control knob and turn to full rate (240°C). Hold a lighted match or taper to the burner and push the control knob in and hold. The burner should ignite and the control knob should be held in for 10 -15 seconds before release.
If the burner goes out, repeat procedure holding control knob for slightly longer.
- For models fitted with Spark Ignition the procedure is similar except that the burner can be ignited by depressing the ignition button, which is located on the fascia. Ignition must be carried out with the door open, and if the burner has not lit within 15 seconds the control knob should be released and the oven left for at least 1 minute before a further attempt to ignite the burner.
- Place the oven shelf in the required position and close the door. Set control knob to approximately 200°C and heat the oven for about 30 minutes to eliminate any residual factory lubricants that might impart

unpleasant smells to the meals being cooked. A non-toxic smoke may occur when using for the first time so open any windows and turn on mechanical ventilators to help remove the smoke.

- Although the oven does heat up quickly, it is recommended that a 10 minute preheat be allowed. The oven should be up to full temperature in about 15-20mins.
- To turn off: turn the control knob until the line on the control knob is aligned with the dot on the control panel.
- Shelf: the shelf has been designed to allow good circulation at the rear of the oven and is also fitted with a raised bar to prevent trays or dishes making contact with the back of the oven. To remove a shelf, pull forward until it stops, raise at front and remove.

Important

The pans and trays supplied with this appliance are the maximum sizes recommended for use. Larger pans and trays may restrict good circulation of heat, increasing cooking times.

Oven Temperature Control

The temperature in the oven is controlled by a thermostatic gas tap and is variable over the range 130°C to 240°C. The temperatures indicated refer to the centre of the oven and at any particular setting the oven will be hotter at the top and cooler towards the base.

The variation between top and centre, and centre to bottom is approximately equivalent to one gas mark. Good use can be made of the temperature variation in several dishes requiring different temperatures may be cooked at the same time. In this way maximum benefit can be obtained from the gas used to heat the oven. Care should be taken not to overload the oven, adequate spacing being used to allow free circulation for heat.

COOKER OPERATION

Operation

Cooking Guidelines

Best results will be obtained by the shelf positions in this guide. It is not necessary to preheat the oven but advisable for a range of dishes. The oven is capable of full temperature in 15-20 minutes.

Most cookery books give details of the shelf positions and gas mark settings for each recipe. If in doubt about a recipe you intend to use, study the recipe carefully then find a similar dish in our guide and use our shelf position and gas mark setting recommendation.

Shelf positions are from the top down. When roasting with aluminium foil care must be taken that the foil does not impair circulation or block the oven flue outlet.

Do's and don'ts

- Do** read the user instructions carefully before using the appliance for the first time.
- Do** allow the oven to heat before using for the first time, in order to expel any smells before the introduction of food.
- Do** clean the appliance regularly.
- Do** remove spills as soon as they occur.
- Do** always use oven gloves when removing food shelves and trays from the oven.
- Do** check that controls are in the off position when finished.
- Do** not allow children near the cooker when in use. Turn pan handles away from the front so that they cannot be caught accidentally.
- Do not** allow fats or oils to build up in the oven trays or base.
- Do not** use abrasive cleaners or powders that will scratch the surfaces of the appliance.
- Do not** under any circumstances use the oven as a space heater.
- Do not** put heavy objects onto open grill and oven doors.

Leaks

If a smell of gas becomes apparent, the supply should be turned off at the cylinder

IMMEDIATELY. Extinguish naked lights including cigarettes and pipes. Do not operate electrical switches. Open all doors and windows to disperse any gas escape. LPG gas is heavier than air; any escaping gas will therefore collect at a low level. The strong unpleasant smell of gas will enable the general area of the leak to be detected. Check that the gas is not escaping from an unlighted appliance. Never check for leaks with a naked flame, leak investigation should be carried out using a leak detector spray.

Maintenance & servicing

Important

- Shut off gas supply at isolating valve, switch off electric supply and ensure all parts are cool before cleaning or servicing
- All servicing must be carried out by an approved competent person.
- After each service the appliance must be checked for gas soundness
- This appliance must not be modified or adjusted unless authorised and carried out by the manufacturer or his representative. No parts other than those supplied by the manufacturer should be used on this appliance.
- If the supply cord is damaged, it must only be replaced by the manufacturer or his representative in order to avoid a hazard.

This appliance needs little maintenance other than cleaning. All parts should be cleaned using warm soapy water. Do not use abrasive cleaners, steel wool or cleansing powders.

When cleaning the burner ring it is essential to ensure that the holes do not become blocked. The control knobs are a push fit and can be removed for cleaning. They are interchangeable without affecting the sense of operation.

Cooker 3 burner gas hob (Sprite only)

IMPORTANT: Before using the appliances for the first time, remove all accessories and packing in the grill and oven, including any surface protection film, i.e. plastic coating. Clean all interior surfaces with hot soapy water to remove any residual protective covering of oil and rinse carefully.

WARNING:

- Accessible parts may be hot when the grill is used, young children should be kept away
- When cooking always ensure young children are kept away

Ensure the gas cylinder is turned on. In the event of a gas smell, turn off at the cylinder and contact supplier. The burners on this appliance have fixed aeration and no adjustment is required. Depending on the gas being used, the burners should flame as follows:

Propane - The flames should burn quietly with a blue/green colour with no sign of yellow tips.

Butane - Normally on initial lighting, as small amount of yellow tipping will occur and then slightly increases as the burner heats up.

Important: The control tap on this appliance operates both the grill and oven burners.

To ensure safe operation it is not possible to operate both burners at the same time.

Using the hob burners


1. Ensure gas cylinder/supply is connected and turned on. In the event of a gas smell turn off at gas cylinder/mains and contact supplier
2. Flame supervision: Each burner is controlled individually and is monitored by a thermocouple probe. In the event of the burner flames being accidentally extinguished, turn off the burner control and do not attempt to re-ignite the burner for at least one minute.

3. To light: Push in the control knob and turn to full rate - see Fig.2. Hold a lighted match or taper to the burner and push the control knob in and hold. It is necessary to hold the knob depressed after the burner has ignited or approximately 10-15 seconds, to allow the thermocouple probe to reach temperature, before releasing the knob. Should the flame go out when the knob is released, the procedure should be repeated holding the knob depressed for slightly longer.
4. For models fitted with spark ignition the procedure is similar except that the burner can be ignited by depressing the ignition button, which is located on the fascia. If the burner has not lit within 15 seconds the control knob should be released and the burner left for at least 1 minute before a further attempt to ignite the burner.
5. For simmering, turn the knob further anti-clockwise to the low rate position.
6. To turn off: Turn the control knob until the line on the control knob is aligned with the dot on the control panel. Always make sure the control knob is in the off position when you have finished using the hotplate burners.

Important: The two in line hob burners on this appliance will support pans from 10cm to 20cm. The single hob burner will support pans from 10cm to 22cm.

WARNING:

- Glass lids may shatter when heated. Turn off the hotplate and allow it to cool before closing the glass lid.
- Remove all spillage from the surface of the glass lid before opening.

 WARNING: The use of the electric hotplate and gas hobs will generate heat. We recommend, to avoid excess build-up of heat around the cooker area, the window is left opened when cooking to allow for additional ventilation. Care should be taken when using the oven as knobs and handle may become hot.

COOKER OPERATION

Using the grill

Important

- The grill must only be used with the door open.
- The heat deflector below the fascia should be pulled out prior to lighting the grill. Never adjust the heat deflector position without using hand protection i.E. Oven gloves.

1. Ensure gas cylinder/supply is connected and turned on. In the event of a gas smell turn off at gas cylinder/mains and contact supplier.
2. To light: Open door, push in the control knob and turn to full rate.
Hold alighted match or taper to the burner and push the control knob in and hold. The burner should ignite and the control knob should be held in for 10-15 seconds before release. If the burner goes out, repeat procedure holding control knob for slightly longer.
3. For models fitted with spark ignition the procedure is similar except that the burner can be ignited by depressing the ignition button, which is located on the fascia. Ignition must be carried out with the door open, and if the burner has not lit within 15 seconds the control knob should be released and the grill left for at least 1 minute before a further attempt to ignite the burner.
4. On first use of the grill, it should be heated for about 20 minutes to eliminate any residual factory lubricants that might impart unpleasant smells to the food being cooked. An non-toxic smoke may occur when using for the first time so open any windows and turn on mechanical ventilators to help remove the smoke.
5. Although the grill does heat up quickly, it is recommended that a few minutes preheat be allowed.
6. Flame Failure Device (FFD): The grill burner is fitted with a flame sensing probe, which will automatically cut off the gas supply in the event of the flame going out. In the

event of the burner flames accidentally being extinguished, turn off the burner control and do not attempt to re-ignite the burner for at least one minute.

7. It is normal for the flames on this burner to develop yellow tips as it heats up, particularly on Butane.
8. A reversible grill pan trivet enables the correct grilling height to be achieved.

Fast toasting -trivet in high position

Grilling sausages -trivet in high position

Grilling steak/bacon -trivet in high position

Grilling chops, etc. - trivet in low position

Slow grilling - trivet removed

9. To turn off: Turn the control knob until the line on the control knob is aligned with the dot on the control panel. Always make sure the control knob is in the off position when you have finished grilling.

Important

- The pan supplied with the appliance is multi functional, for use either whilst grilling or when using the oven.
- The handle design allows removal or insertion whilst the pan is in use.

Using the oven

1. Ensure gas cylinder/supply is connected and turned on. In the event of a gas smell turn off at gas cylinder/mains and contact supplier.
2. To light: Open door, push in the control knob and turn to gas mark 9. Hold a lighted match or taper to the burner and push the control knob in and hold. The burner should ignite and the control knob should be held in for 10-15 seconds before release. If the burner goes out, repeat the process holding control knob for slightly longer.
3. For models fitted with spark ignition the procedure is similar except that the burner can be ignited by depressing the ignition button, which is located on the fascia. Ignition must be carried out with the door open, and if the burner has not lit within

15 seconds the control knob should be released and the oven left for at least one minute before a further attempt to ignite the burner.

4. Place the oven shelf in the required position and close the door. Set control knob to approximately gas mark 5 and heat the oven for about 30 minutes to eliminate any residual factory lubricants that might impart unpleasant smells to the meals being cooked. A non-toxic smoke may occur when using for the first time so open any windows and turn on mechanical ventilators to help remove the smoke.
5. Although the oven does heat up quickly, it is recommended that a 10 minute pre-heat should be allowed. The oven should be up to full temperature in about 15-20 minutes
6. To turn off: Turn the control knob until the line on the control knob is aligned with the dot on the control panel.
7. Shelf: The shelf has been designed to allow good circulation at the rear of the oven and are also fitted with a raised bar to prevent trays or dishes making contact with the back of the oven. To remove a shelf, pull forward until it stops, raise at front and remove.

Oven temperature control

The temperature in the oven is controlled by a thermostatic gas tap and is variable over the range 130°C to 240°C. Approximate temperatures for the settings on the control knob are shown in the table below. The temperatures indicated refer to the centre of the oven and at any particular setting the oven will be hotter at the top and cooler towards the base.

The variation between top and centre, and centre to bottom is approximately equivalent to one gas mark. Good use can be made of the temperature variation in several dishes requiring different temperatures may be cooked at the same time. In this way maximum benefit can be obtained from the gas used to heat the oven. Care should be taken not to overload the oven, adequate spacing being used to allow free circulation for heat.

Cooking guidelines

See user instructions.

Do's and Don'ts

- Do** read the user instructions carefully before using the appliance for the first time.
- Do** allow the oven to heat before using for the first time, in order to expel any smells before the introduction of food.
- Do** clean the appliance regularly.
- Do** remove spills as soon as they occur.
- Do** always use oven gloves when removing food shelves and trays from the oven.
- Do** check that controls are in the off position.
- Don't** allow children near the cooker when in use. Turn pan handles away from the front so that they cannot be caught accidentally.
- Don't** allow fats or oils to build up in the oven tray or base.
- Don't** use abrasive cleaners or powders that will scratch the surfaces of the appliance.
- Don't** under any circumstances use the oven as a space heater.
- Don't** put heavy objects onto open grill and oven doors.

Leaks

If a smell of gas becomes apparent, the supply should be turned off at the cylinder

IMMEDIATELY. Extinguish naked lights including cigarettes and pipes. Do not operate electrical switches. Open all doors and windows to disperse any gas escape.

Butane/Propane gas is heavier than air; any escaping gas will therefore collect at low level.

The strong unpleasant smell of gas will enable the general area of the leak to be detected.

MICROWAVE

Check that the gas is not escaping from an unlighted appliance. Never check for leaks with a naked flame, leak investigation should be carried out using a leak detector spray.

Microwave oven general user instructions

Always refer to the microwave operating instructions supplied with the vehicle

Precautions to avoid possible exposure to excessive microwave energy

- a. Do not attempt to operate this oven with the door open since open door operation can result in harmful exposure to microwave energy. It is important not to defeat or tamper with the safety interlocks.
- b. Do not place any objects between the oven front face of the door or allow soil or cleaner residue to accumulate on sealing surfaces.

⚠ WARNING:

- c. if the door or door seals are damaged, the oven must not be operated until it has been repaired by a competent person (1) door broken (2) hinges and latches (broken or loosened), (3) door seals and sealing surfaces.

⚠ WARNING:

- d. it is hazardous for anyone other than a competent person to carry out a service or repair operation.

⚠ WARNING:

- e. liquids or other foods must not be heated in sealed containers since they are liable to explode.

⚠ WARNING:

- f. only allow children to use the oven without supervision when adequate instruction has been given so that the child is able to use the oven in a safe way and understands the hazards of improper use.

Important safety guidance

⚠ WARNING: To prevent fire, burns, electric shock and other warnings: Listed below are, as with all appliances, certain rules to follow and safeguards to assure high performance from this oven:

Important instructions

1. Do not use the oven for any reason other than food preparation, such as for drying clothes, paper, or any other non food items or for sterilizing purposes.
2. Do not use the oven when empty, this could damage the oven.
3. Do not use the oven cavity for any type of storage, such as papers, cookbook, cookware etc.
- 4 Do not operate the oven without the glass tray in place. Be sure it is sitting properly on the rotating base.
5. Make sure you remove caps or lids prior to cooking when you cook food sealed in bottles.
6. Do not put foreign material between the oven surface and door. It could result in excessive leakage of microwave energy.
7. Do not use recycled paper products for cooking. They may contain impurities which could cause sparks and/or fires when used during cooking.
8. Do not pop popcorn unless popped in a microwave approved popcorn popper or unless it's commercially packaged and recommended especially for microwave ovens. Microwave popped corn produces a lower yield than conventional popping; there will be a number of unpopped kernels. Do not use oil unless specified by the manufacturer.
9. Do not cook any food surrounded by a membrane, such as egg yolks, potatoes, chicken livers, etc., without first piercing them several times with a fork.

10. Do not pop popcorn longer than the manufacturer's directions. (Popping time is generally below 3minutes). Longer cooking does not yield more popped corn it can cause scorching and fire. Also, the cooking tray can become too hot to handle or may break.
11. If smoke is observed, switch off or unplug the appliance and keep the door closed in order to stifle any flames.
12. When heating food in plastic or paper containers, keep an eye on the oven due to the possibility of ignition.
13. The contents of feeding bottles and baby food jars shall be stirred or shaken and the temperature checked before consumption, in order to avoid burns.
14. Always test the temperature of food or drink which has been heated in a microwave oven before you give it to somebody, especially to children or elderly people. This is important because things which have been heated in a microwave oven carry on getting hotter even though the microwave oven cooking has stopped.
15. Eggs in their shell and whole hard-boiled eggs should not be heated in microwave ovens since they may explode, even after microwave heating has ended.
16. Keep the waveguide cover clean at all times. Wipe the oven interior with a soft damp cloth after each use. If you leave grease or fat anywhere in the cavity it may overheat, smoke or even catch fire when next using the oven.
17. Never heat oil or fat for deep frying as you cannot control the temperature and doing so may lead to overheating and fire.
18. Liquids, such as water, coffee, or tea are able to be overheated beyond the boiling point without appearing to be boiling due to surface tension of the liquid. Visible bubbling or boiling when the container is removed from the microwave oven is not always present. **This could result in very hot liquid suddenly boiling over when a spoon or other utensil is inserted into the liquid.**

To reduce the risk of Injury to persons:

- a. Do not overheat the liquid.
- b. Stir the liquid both before and halfway through heating it.
- c. Do not use straight-sided containers with narrow necks.
- d. After heating, allow the container to stand in the microwave oven for a short time before removing the container
- e. Use extreme care when inserting a spoon or other utensil into the container.

Care of the microwave

1. Turn the oven off before cleaning
2. Keep the inside of the oven clean. When food spatters or spilled liquids adhere to oven walls, wipe with a damp cloth. Mild detergent may be used if the oven gets very dirty. The use of harsh detergent or abrasives is not recommended.
3. The outside oven surface should be cleaned with soap and water, rinsed and dried with a soft cloth. To prevent damage to the operating parts inside the oven, water should not be allowed to seep into the ventilation openings.
4. If the central panel becomes wet, clean with a soft dry cloth. Do not use harsh detergents or abrasives on Control Panel.
5. If steam accumulates inside or around the outside of the oven door, wipe with a soft cloth. This may occur when the microwave oven is operated under high humidity conditions and in no way indicates malfunction of the unit.
6. It is occasionally necessary to remove the glass tray for cleaning. Wash the tray in warm sudsy water or in a dishwasher.
7. The roller guide and oven cavity floor should be cleaned regular/y to avoid excessive noise. Simply wipe the bottom surface of the oven with mild detergent water or window cleaner and dry. The roller guide may be washed in mild sudsy water.

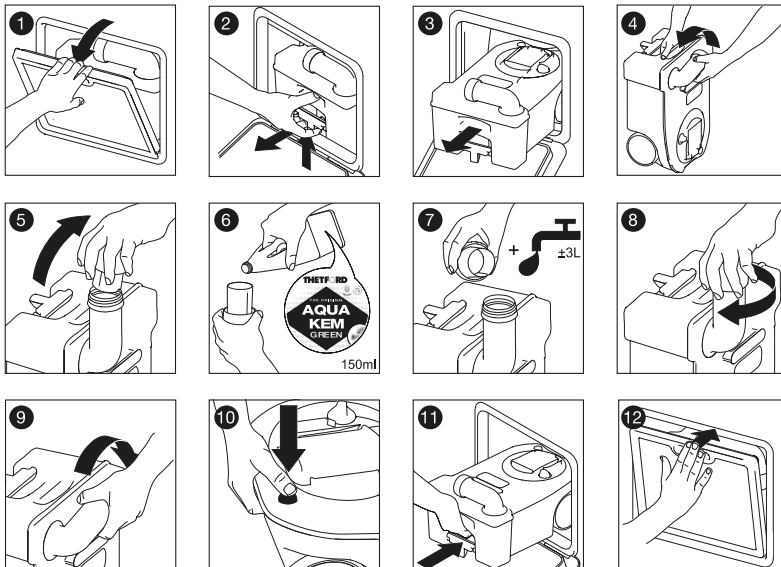
MICROWAVE

8. The oven should be cleaned regularly and any food deposits removed;
9. Failure to maintain the oven in a clean condition could lead to deterioration of the surface that could adversely affect the life of the appliance and possibly result in a hazardous situation.

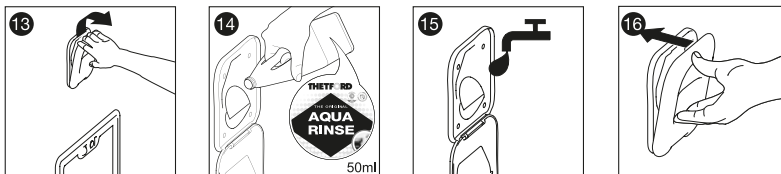
Thetford C260 Cassette Toilet

Quick Guide

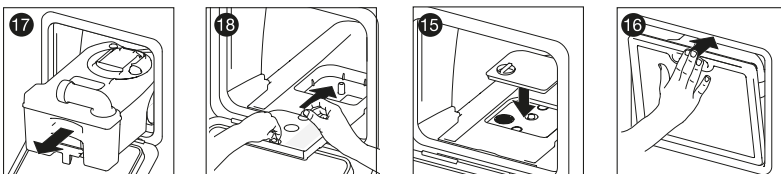
Preparing waste holding tank



Preparing flush-water tank (only for C262-models)

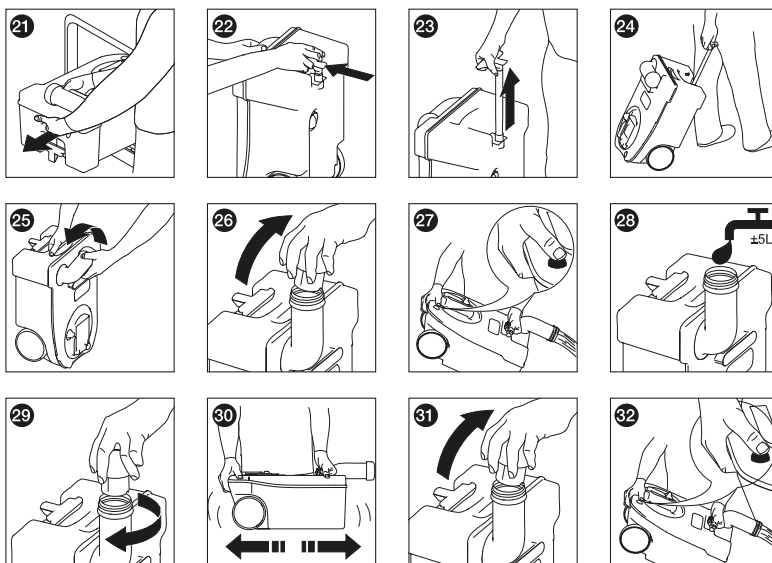


Preparing Electric Ventilator (if applicable)

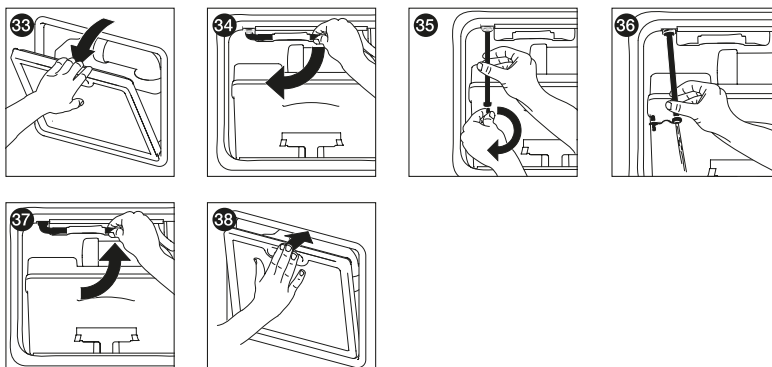


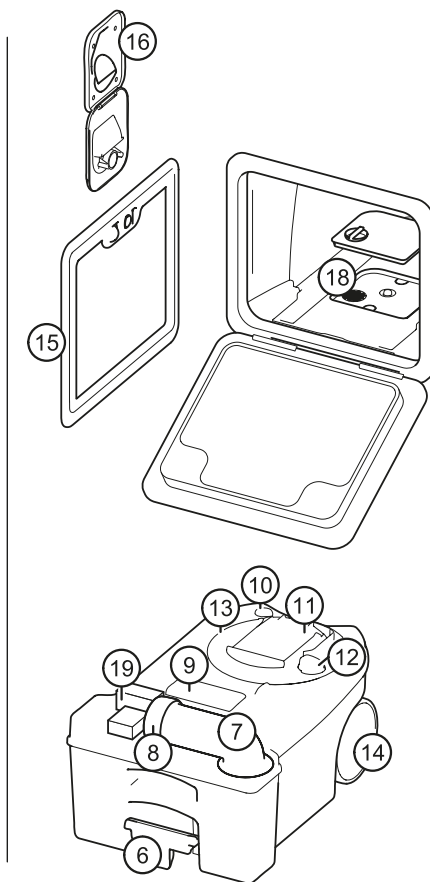
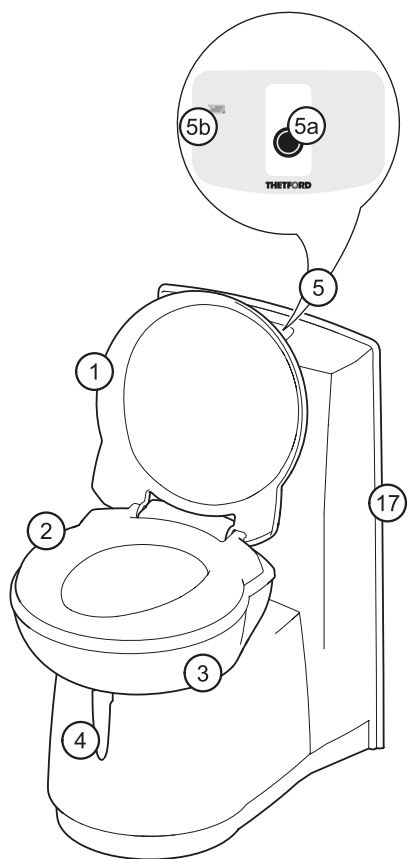
CASSETTE TOILET

Emptying waste-holding tank



Emptying flush-water tank (only for C262-models)





Standard

- 1. Cover
- 2. Seat
- 3. Swivelling toilet bowl
- 4. Blade handle to open/close blade
- 5. Control panel (position is different on C263 models)
- 5a. Flush button
- 5b. Waste holding tank level indication (1 level or 3 levels; dependent on model)
- 6. Pull handle

- 7. Pour out spout
- 8. Cap with measuring cup
- 9. Automatic pressure release vent
- 10. Vent button
- 11. Sliding cover
- 12. Blade opener
- 13. Waste holding tank mechanism
- 14. Wheel
- 15. Service door 3

CASSETTE TOILET

Options

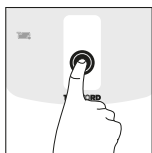
16. Waterfill door (only for C262 models)
17. Console with flush water tank (only for C262 models)
18. Filter for electric ventilator
19. Location waste pump out system

Introduction

This Thetford Cassette Toilet is a high quality product. It is user-friendly, meets high quality standards and gives you all the convenience of home.

Before operating and using this toilet we advise you to read the manual completely. Keep this manual in a safe place for future reference.

For the latest version of the manual please visit www.thetford.eu

Possible toilet options

Some toilets are fitted with extra options. To check which options are available, press the flush button on the control panel.

The following symbols can light up:

- **Waste pump out system** - transfers waste from the waste holding tank into the vehicle's central waste tank.
- **Electric blade** - electrically opens or close the blade.
- **Electric ventilator** - draws unpleasant odours away from the waste tank to the outside of the vehicle.

You will find additional to these options in the grey text boxes. Thoroughly read the applicable instructions.

Preparing for use

This cassette toilet has a waste holding tank of 17.5L. A C262 model also has its own 8L flush water tank. Before using your toilet, it is vital that you add toilet additive to these tanks. Check the correct dosage on the additive

package. Then add $\pm 3L$ of water to the waste holding tank. Fill the flush water tank of a C262 model to the top.

Electric ventilator (if applicable)

Open the service door and remove the waste holding tank. Then remove the filter housing cover and place the new filter into the filter housing. Replace the cover and return the waste holding tank back to original position.

⚠ WARNING: Never add toilet additives directly via the blade as this could damage the lip seal of the waste holding tank. Only fill the waste holding tank via the pour out spout.

⚠ WARNING: Never use force if you cannot get the waste holding tank back into place easily. If blockage occurs, always check if the blade handle is in the closed position.

See Quick guide diagrams 1-20 for visual reference. To depressurise the waste holding tank, press the vent button before placing the tank back in its position.

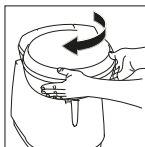
Thetford offers a pleasantly scented toilet fluid for the flush water tank (Aqua Rinse) and a variety of waste holding tank products (Aqua Kem Blue, Aqua Kem Green, Aqua Kem Natural, Aqua Kem Sachets).

Aqua Rinse keeps the flush water fresh, ensures a smooth flush and leaves a protective layer. All products for the waste holding tank suppress unpleasant smells, stimulate the breakdown of waste, reduce the formation of gas, protect moving parts and help to the waste holding tank fresh and clean. For the differences between the distinguishing qualities of each waste holding tank product please visit www.thetford.eu

The range of available Toilet Care products may vary for each country.

Use of your toilet

Turning the bowl



You can turn this bowl to a desired position (max. $\pm 90^\circ\text{C}$). Close the cover and use both hands to rotate the bowl as illustrated.

Opening the blade

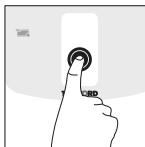


The toilet can be used with the blade open or closed. To open the blade, slide the blade sideways as illustrated. Make sure you always close the blade completely after use.

Electric blade (if applicable)

Press the flush button to activate the control panel. Then push the Electric blade button. The blade will open or close electrically.

Flushing the toilet



Press the flush button once to activate the control panel. Then press the flush button for several seconds to flush the toilet.

Electric ventilator (if applicable)

By activating the control panel, the Electric ventilator start automatically. The button will flash to indicate this function is active. To stop the Electric ventilator, press the button. Press the button again to restore the Electric ventilator. To optimise its function, activate the Electric ventilator before use of your toilet.

Note: Even without an own flush water tank you can still use Aqua Rinse for a smooth and fresh lavender scented flush. Simply spray Aqua Rinse with a spray can evenly into the toilet bowl before use.

Note: Ordinary toilet paper can cause clogging. Use Aqua Soft toilet paper instead. This toilet paper is super soft, dissolves quickly, prevents clogging and makes it easier to empty the waste holding tank.

Level indication

You can check whether your waste holding tank has a 1 level or a 3 level indication. Make sure the tank is empty and place it properly. Then activate the control panel. If no level indication light lights up, your toilet has a 1 level indication. It will only indicate a full tank. If a green level indication light immediately lights up, your toilet has a 3 level indication. It will indicate empty, half full and full.

Emptying the tank

Waste holding tank

When the red light of the level indicator on the control panel lights up, you need to empty the waste holding tank. Remove the tank via the service door. Then take it to an authorised waste disposal point. Empty the waste holding tank via the pour out spout.

⚠ WARNING: Do not lift the coupling head by hand when hitching the caravan to the car. Always raise and lower the coupling head by winding the handle on the jockey wheel up and down.

Waste pump out system (if applicable)

By activating the control panel, this button automatically lights up. Press the button to empty the waste holding tank into the vehicle's central waste tank. The button flashes while the waste is being pumped and stops flashing when all waste has been transferred. ($\pm 1.5\text{L}$ of waste is left). If the central waste tank is too full (only measured when this tank has a level indicator), the button flashes rapidly and no pump out is possible until you have emptied the central waste tank.

CASSETTE TOILET

See 'Quick guide' diagrams 21-32 for visual reference. If you want to continue using your toilet after emptying, prepare the waste holding tank again.

Note: Our 'green' products Aqua Kem Green, Aqua Kem Natural and Aqua Rinse (test ISO 11734) are absolutely safe to empty into a septic tank or small biological systems on camping sites.

⚠ WARNING: Please avoid travel with a waste holding tank that is more than 3/4 full. This may cause leakage through the venting system.

Flush water tank (only for C262 models)

The flush water tank has a capacity of 8L. Only empty the flush water tank completely if you don't expect to use your toilet for a long (winter) period. Place a sufficiently large bowl under the drain tube and catch the remaining water. Empty this bowl at an authorised waste disposal point.

See 'Quick guide' diagrams 33-38 for visual reference.

⚠ WARNING: To prevent water damage to your caravan, ensure you don't travel with a full flush water tank or with water in the bowl.

Cleaning

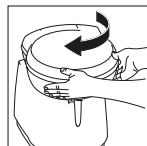
Just like your toilet at home, it is also important to clean this cassette toilet regularly. You will prevent limescale and ensure optimal hygiene. Clean the inside of the bowl with toilet bowl cleaner and a soft brush and use bathroom cleaner for the outside of the toilet.

⚠ WARNING: Never use the household cleaners to clean your toilet. These may cause permanent damage to the seals and other toilet components.

Waste pump out system (if applicable)

Fill the emptied waste holding tank with water and place the tank back. Then activate the control panel. Press the waste pump out system button to pump the water through the system. Do this once every 3 weeks.

Remove seat and cover



To clean your toilet thoroughly, remove the seat and cover. First push the seat and cover together to the right then lift them up.

Winter use

You can use your toilet as normal in cold weather as long as the toilet is situated in a heated location. If this is not the case, and there is a risk of frost, we advise not to use your toilet. Make sure you completely empty the waste holding tank. For a C262 model also empty the flush water tank.

Note: Aqua Kem Sachets are particularly suitable for winter camping as the sachets are filled with powder. They completely dissolve in water, are easy to dose and economical in use.

Maintenance

To prolong the life span of your toilet, maintain your toilet regularly. Use cassette tank cleaner 2 to 3 times a year on the waste holding tank.

It safely removes stubborn limescale on the inside of the tank. When seals become dry, use seal lubricant to keep the seals soft and pliable. It has been specially developed for mobile toilets and is absolutely safe to use.

⚠ WARNING: Never use Vaseline or vegetable oil to lubricate the seals as these may cause leakage to your waste holding tank.

Waste pump out system (if applicable)

To ensure optimal functionality, maintain the waste holding tank regularly. Fill the waste holding tank with water and rinse it. Then use Cassette Tank Cleaner. Do this every 6 weeks when on holiday.

Electric Ventilator (if applicable)

After approximately 4 weeks of use, the filter loses its absorption power. Remove the filter housing cover and place the new filter into the new housing.

Storage

If you don't expect to use your toilet for a long period, you have to thoroughly empty, clean and dry the whole toilet. Also empty the flush water tank of a C262 model. This is also a good moment to maintain your toilet. During storage we advise leaving the blade open to prevent damage to the blade and to loosen the cap of the pour out spout to ventilate the waste holding tank.

Electric ventilator (if applicable)

Remove the filter of the filter housing.

Disposal

Your product has been designed and manufactured with high quality material and components, which can be recycled and reused. When your toilet has reached the end of its life, dispose of the product according to the local rules. Do not use the toilet with the normal household waste. The correct disposal of your old product will help prevent potential negative consequences for the environment and human health.

Questions?

If you require further information or have any questions about your toilet, please visit our website www.thetford.eu If you still have questions, contact the Customer Service Department in your country or your holiday location.

For correct and efficient support, please ensure all relevant product type information is available.

Spare parts

Original Thetford spare parts are available through your own dealer or an authorised Thetford Service Centre.

FAQs

What should I do in case of a defect on my Thetford toilet? Contact your dealer where you bought your vehicle, or if you are on holiday, contact an authorised Thetford Service Centre.

A red light on the control panel flashes, what should I do? Check if the waste holding tank is present or positioned properly.

I cannot move my waste holding tank. Check if the blade of your toilet is completely closed.

What should I do when the electric blade doesn't function? Manually open or close the blade by sliding the small handle under the toilet bowl sideways.

What should I do if the blade is blocked? Loosen the cap with measuring cap from the pour out spout and try again.

Does the toilet have a fuse? Yes, the toilet has a maintenance free self-resetting fuse.

Warranty

Thetford BV offers the end users of its products a three-year guarantee. In the case of malfunction within the warranty period, Thetford will replace or repair the product at its discretion. In this case, the costs of replacement, labour costs for the replacement of defective components and/or the costs of the parts themselves will be paid by Thetford.

1. To make a claim under this guarantee, the user must take the product to his dealer or an authorised Thetford Service Centre (www.thetford.eu). The claim will be assessed there.

EXTERNAL BBQ POINT

2. Components replaced during repair under guarantee become the property of Thetford.
3. This warranty does not prejudice current consumer protection laws.
4. This warranty is not valid in the case of products that are for, or are used for, commercial purposes.

Guarantee claims falling into one of the following categories will not be accepted:

- the product has been improperly used or the instructions in the manual have been followed (for example incorrect use of additives;
 - alterations have been made to the product;
 - the product has been repaired by an unauthorised Thetford Service Centre;
 - the product code or serial ID has been changed;
 - the product has been damaged by circumstances outside the normal use of the product.
5. Not using Thetford products to care for your Thetford toilet could create some damage, which would not be covered by this warranty.

Thetford is not liable for any loss and/or damage caused directly or indirectly by use of the toilet.

Caravans with external barbeque point

Models equipped with an external barbeque point can be used to power any gas appliance suitable for the gas used in the caravan, at the working pressure shown on the label in the barbeque outlet box. Please note when using the outlet that the fitted regulator will allow a maximum of 1.5kg per hour of gas to be taken from the gas bottle. Therefore the consumption of gas from both the appliances within the caravan and the appliance connected to the barbeque point cannot exceed a total of 1.5kg per hour at any one time. If you are in any doubt please consult your dealer for advice. To use point proceed as follows:



When external gas equipment is being connected, the operating pressure of the gas supply of 30 or 50 mbar must correspond with the operating pressure of the equipment that is being connected (see data plate).

The plug-in connection can only be made if the quick acting valve is closed. The safety locking mechanism can be released by sliding back the coupling sleeve.

The coupling K-valve is being designed such that the quick acting valve can only be opened if the connection is being made via the plug-in connection. The connection is made by inserting the plug-in connection into the safety coupling.

This operation can be carried out using one hand. After uncoupling the equipment, seal off the valve opening using the protection seal.

Note: The external gas socket is only suitable for removing gas, not for feeding gas into the gas system.

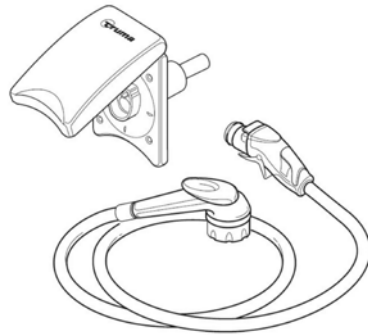
⚠ WARNING: Care should be taken when using the external barbeque point. Never barbeque next to an awning or tent.

⚠ WARNING: The caravan barbeque point should only be used as an outlet point for gas, never connect a gas bottle direct to the outlet.



External shower point

The external shower point, if fitted, will be supplied with a separate shower head and hose assembly. To connect the shower, simply align the plug with the socket and push into position. To remove, pull the lower trigger and pull the plug from the socket.

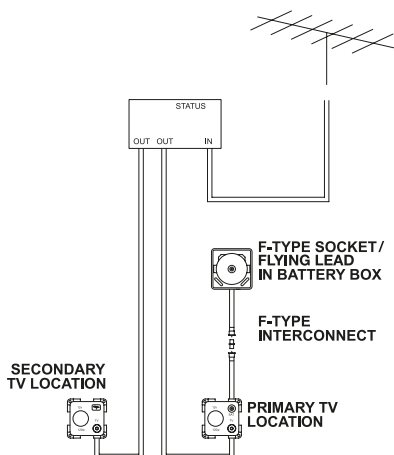


Caravans with TV inlet in battery box

Models equipped with TV points in the battery box have the facility to take an external signal and supply that signal to TV points within the caravan.

Caravans equipped in this way feature a direct link from the connection point in the battery box, to an auxiliary connection point at the primary TV position within the caravan. The primary TV position is that which also features an AV outlet plate (see later text).

TV INLET



The direct link can be used to:

1. Supply an external signal (caravan site TV feed) to the primary TV position
 - a. Connect the socket in the battery box (on flying lead depending on model), with a suitable lead, to the appropriate socket on the caravan site supply post. As the connector in the battery box is a screw on 'F-type' connector, an adaptor to convert this to a 'push-on' co-ax connector, which may be required, has been supplied with your caravan.
 - b. Locate the primary TV position within the caravan. At the 12V, TV and SAT socket, connect your TV to the output from the socket marked SAT with a suitable lead.
2. Connect an external satellite dish to a decoder within the caravan. (The direct link uses F-type interconnects throughout to allow the decoder and dish to communicate correctly)
 - a. Connect the dish to the socket (or flying lead) in the battery box with a suitable lead. The F-type to co-ax adaptor should not be used.
 - b. Connect the dish input connection on the decoder to the 'SAT' socket on the 12V, TV and SAT socket located in the primary TV location.

3. Supply a signal from within the caravan to the exterior of the caravan
 - a. Connect the output from your VCR, DVD player or other device to the SAT connection on the 12V, TV and SAT socket at the primary TV position.
 - b. Connect your receiving device (TV or similar) to the socket in the battery box with a suitable lead.

As can be seen from the simplified schematic, when multiple TV locations are present in a van, all of these receive signals from the TV aerial connection box. Using adaptors and link cables which are readily available, it may be possible to re-direct a signal from the 'SAT' connection at the primary TV location, up to the aerial connection box to be then distributed to other TV positions within the caravan. Please remember that as the number of connections increases the quality of the signal reduces.

Supplier fitted / supplied entertainment equipment

Audio-visual equipment may have been fitted by your dealer, or supplied with the caravan, depending on the specification of the caravan. Although not specific, below are details of the types of equipment which would be fitted as appropriate to the specification of the caravan:

CD/MP3/tuner with auxiliary input

Where provision has been made in the furniture to install a head unit similar in appearance to that fitted in the dashboard of a car. The unit operates as a CD player and FM/AM radio. In addition MP3 files stored on a CD can be read and played by the unit. An auxiliary input on the front of the unit allows a separate MP3 player to be connected from that player's headphone socket. (A separate lead may be required).

Speakers mounted in the front locker of the caravan are connected to this head unit for a stereo sound output. A retractable AM/FM aerial on the side of the caravan, enables reception of radio stations.

STATUS 550 DIRECTIONAL TV AND FM RADIO ANTENNA

STATUS 550 DIRECTIONAL TV AND FM RADIO ANTENNA (model dependant)

Firstly determine the approximate location of the nearest transmitter and whether the signals are horizontally or vertically polarized. For assistance ask your site operator or check antennas in the vicinity

1. Loosen the Mast Locking Collar and Wall Bracket and raise the antenna. Turn the mast to direct the Antenna towards the TV transmitter.

The RED spot on the bottom of the mast indicates the front of the Antenna.

2. When receiving vertically polarized signals, rotate the winder anti-clockwise to cant the antenna through 90°. The red / green indicator, if present, indicates vertical or horizontal orientation.

Note: DO NOT over tighten or use undue force on the winder.

3. Switch ON the Power Pack and the RED LED will illuminate.
4. Check the gain control switch is set to normal – NML.
5. Tune your television to the strongest signal. You may need to adjust the direction of the mast to achieve the best quality picture.
6. Secure by tightening the Mast Locking Collar and Wall Bracket

Removing the antenna

A permanently fitted Status can be easily removed leaving only the Mounting Foot and rubber gaiter.

1. Unplug the antenna from the Power Pack.
2. Loosen the Mast Locking Collar and Wall Bracket and lift off whilst feeding out the cable.
3. Push the Blanking Cap supplied into place.

⚠ WARNING: The Blanking Cap is a temporary seal and is not for long term use.

⚠ WARNING: Always ensure the aerial is lowered before driving off.

BEDDING

Bedding

Sleeping bags and duvets can be compressed into small spaces and can be ready to use in minutes.



Fig. A



Fig. B

Lower single beds assembly (Figs. A & B)

1. Lower dinette table and place between the recess in both seats.
2. Arrange seat cushions as appropriate.

Double bed assembly (Fig. C)

1. Grip front of slatted bed and walk backwards until bed is fully extended.
2. Arrange seat cushions as appropriate.



Fig. C

Lift-up bunks

1. Grasp the bunk and pull carefully upwards and towards you. **(Fig. D)**
2. The bunk is designed to automatically move into the correct position. **(Fig. E)**
3. Where a bed board is fitted, unfold and make sure it is secured by press studs when lifted into position. (The bed board is required to protect both the occupant and the window from damage during use of the bunk.) **(Fig. F)**
4. Locate safety boards. **(Fig. G)**
5. Arrange seat cushions as appropriate. **(Fig. G)**

Bunks are designed to carry a child to a maximum of 70kg (11 stone)

⚠ WARNING: use the upper bunks for sleeping only, with the provided protection against fall out in position.

⚠ WARNING: Care shall be taken against the risk of fall out when the upper bunks are in use by children especially under 6 years of age, these bunks are not suitable for use by infants without supervision.



Operating instructions for softrollo blinds



Hold the operating aluminium bar in the middle and raise or lower the blind and flyscreen independently, operating together will require excessive force in operation.

Care instructions: Clean the blind only with a damp sponge. Clean on a regular basis to avoid dirt particle build up as this can damage the blind material.

Use only water or with mild suds or a vacuum cleaner.

In order to avoid material fatigue, do not leave the flynet closed for a long time.

Maintenance

If operation of the soft Rollo blind is exceptionally stiff, it is possible to spray the guide - legs (left and right) with a Teflon - spray. This will ease both the operation of the blind and avoid any interruption/malfunction from deposits in the guide legs which may affect the operation.

Doorscreen

When drawing or releasing the doorscreen, care should be taken not to let it spring back freely, this may result in damage to the screen or its fittings.

ROOFLIGHT



Always pull the doorscreen close to the centre. It is not advisable to pull close to the top or bottom as this will cause snagging and uneven running.

⚠ WARNING: When opening or releasing the doorscreen, care must be taken to avoid trapping fingers. When opening or releasing the doorscreen, care must be taken to avoid trapping fingers.

The door flynet operates independently of the door by sliding across the door threshold.

Roof lights

When opening the roof lights, care must be taken to release the locking mechanism as the unit is raised.

Roof lights must be fully closed when towing.

Roof lights provide varying levels of fixed ventilation.

Exterior Door Key

⚠ WARNING: Care should be taken not to leave the exterior door key in the door when unlocking the door. The key may result in damage in the vehicle side if the door is released with the key still in the lock.

Windows

To open all window types turn the internal handles through 90 degrees and push open the window.

On models fitted with telescopic stays:

push open the window to the desired position and tighten the stay. To close the window, loosen the stays and slowly close taking care to fold the stay inside the window and lock off the handles by turning back through 90 degrees.

On models fitted with ratchet stays:

the window locks in the open position to pre-set positions located within the stay. To operate, push open the window until you hear an audible click and then slowly release the pane and the window will be locked in the first open position. Push open again to find the next locking position. To close, fully open the window which will disengage the locks and allow the window to close slowly and lock off the handles by turning back through 90 degrees.

Windows / Roller Blind Advice

In case of prolonged exposure to the sun roller blinds should not be completely closed as this could cause excessive heat concentration at the top of the window, due to characteristics of the glazing material the windows could be adversely affected.

Roller blinds that shade from the bottom upwards it is necessary to leave a gap of a few centimetres open at the top, this way the heat between window and blind can escape. A fly screen does not cause an obstruction.

Roller blinds that shade from the top downwards must be kept completely open, or be opened regularly to allow the heat to escape.

Keeping the windows in ventilation position allows heat to escape.

Never fully close a roller blind system when storing the vehicle or when not in use for longer periods!

Therefore for optimal window life it is recommended:-

- Blinds starting at the bottom of the window a gap should be provided for ventilation at the top with the window in its ventilation position.
- For vehicles containing blinds from the top downwards or with other types of reflective blinds / curtains, please make sure that these blinds are also ventilated or not fully closed.

Ensure that all windows and roof vents are closed when the vehicle travels on the road.

Heki-2 roof light (Seitz)

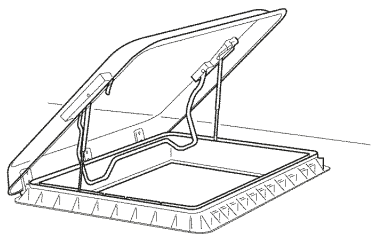
The lift/tilt roof light can be set in 3 positions by means of pneumatic springs.

Position 1 lifts the pane 12mm without allowing rain to enter the caravan.

Position 2 sets the pane to a 150mm opening and locks with a bar.

Position 3 opens the pane through 55°.

A fully adjustable flyscreen and black-out screen are built into the inner frame. The flyscreen can be drawn independently and the black-out screen is variable for partial or full black-out.



Forced ventilation functions via a brush lined duct instead of a ventilated pane.

A cover hood can be fitted for winter protection.

Heki-2 roof lights provide 13,200mm² of fixed ventilation.

Mini Heki rooflight

To open depress button and push bar upwards. The rooflight has two open ventilation positions and a fully open position.

The blind and flynet operate independently of each other and are engaged by connecting to each other and sliding.

Heki care instructions: Clean the blind only with a damp sponge. Clean on a regular basis to avoid dust/ dirt particle build up as this can damage the blind material. Use only water or with mild suds or a vacuum cleaner.

In order to avoid material fatigue, do not leave the flynet closed for a long time.

Care of laminate tops, tables, furniture and doors

Do not use abrasives, chemically treated cloths or aggressive detergents as these may cause damage

Do not place hot objects on laminated surfaces i.e. tops, tables. Any temperatures 70°C and over may cause permanent damage.

Clean worktop surfaces, furniture and door fascias with a soft, slightly damp cloth, dry off with a soft cloth.

Doors

In order to provide customers with the latest designs of door furniture it is possible, due to the use of natural wood, that warping may occur. This should not detract from the correct functioning of items fitted in the caravan.

Information

During the normal travelling vehicle vibration and flexing may cause some of the furniture doors to become out of alignment.

For your convenience many hinges are adjustable.

Tables

Slide the top of the chest of drawers forward to form a convenient table. Lift the rear portion to slide the top away. (Fig. A)



⚠ WARNING: When erecting the free standing table, be careful to avoid trapping fingers.

Table storage

To avoid damage care must be taken when removing tables from their stored position.

Where two tables are stored together in a low level storage area care should be taken to remove the table positioned opposite the hinged edge first.

Tables stored in the table storage compartment must be securely clipped into place whilst in transit.

12V reading lamp

⚠ WARNING: 12v tungsten reading/spotlamps generate high temperatures when in use, the body, lens/ bulb may become very hot. NEVER make directional adjustment in the direction of flammable materials i.e. curtains, nets or blinds.

Shower heads

- Care should be taken as water may become hot temporarily when switched on until it mixes and regulates.
- Small children should be supervised at all times when using the shower.
- We recommend unfastening the shower head before travelling and storing safely to prevent it becoming detached whilst towing.

Fixing of awnings

In order to avoid puncturing the outer skin of the caravan wall, it is recommended that awning poles are fixed to your caravan using load spreading eyelet pads or rubber sucker pads.

Attaching awning brackets and associated fixings to your caravan by using mechanical methods which pierce the outer skin of the caravan wall can allow water ingress which will invalidate the product warranty.

Important:

Care must be taken when using an awning as poles and suckers can cause damage to exterior side panels.

Awnings should be taken down in strong winds to protect the side panels from cosmetic damage and dents from the awning poles.

Note: Awnings should be kept ventilated when discharging products of combustion exhaust into them.

Awning Sizes

Due to the various awning types and sizes the awning sizes provided in the Service and Warranty Handbook are for guidance only.

Full details and sizes of awnings (A-A dimensions) for your caravan can be found in your Technical Handbook.

Specific awning sizes must be confirmed with the dealer or awning manufacturer prior to purchase.

Colour reference

If a customer requires touch-up paint or a respray of a caravan, the correct colour code for all white components is Fiat White 249.

Please be aware that colours can fade over time, and therefore, if the vehicle is more than a few years old, it is suggested a colour match be obtained.

Silver caravans do not have a specified colour code, and therefore, a colour match must always be obtained.

Drop down TV mechanism

In some models, a drop down TV mechanism is used. Customers are reminded to engage both positive locks, on the underside of the TV mechanism before travelling. Failure to do so may result in damage of the TV unit or the TV shelf itself.

The inner dimensions (i.e. maximum TV size) for this unit is 336mm high x 390mm wide x 70mm deep

Front locker and sunroof

The front locker is made from ABS thermoformed plastics, which are easy clean textured surfaces. To ensure long life and prevent damage you must not use any cleaning materials including solvents or aggressive cleaning materials. We recommend the use of warm soapy water, applied with a damp cloth.

Where a front sunroof is fitted, directly above the front windows, it is recommended that the blind be left open during use (or storage) in high temperatures or direct sunlight, to avoid a build-up of heat within this non-opening window.

Bonded Roof

The roof of your caravan is made from a bonded construction. Care should be taken when cleaning the roof not to walk directly on the roof. If access to the roof is required the weight of a person should be spread across a larger area using a spreader board and extreme care should be taken when working at heights.

Step on hitch cover

Where a step on hitch cover is fitted, customers are reminded only to stand on the designated areas, identified with black anti-slip matting. Stepping elsewhere on the hitch cover may result in damage to the hitch cover.

Models without a step on hitch cover are not suitable for standing on and failure to follow these simple instructions may result in premature failure or cracking which will not be covered by any guarantees (including extended warranties).

CYCLE RACKS

Cycle racks

The Swift Group allows the fitment of a two cycle rack to our caravans and we have made provision for fixing blocks on most models for this purpose.

Due to the complex nature of a cycle rack, the different models available and the need to break into the habitation box (therefore, having a potential of a leak), we suggest this modification only be carried out by a competent person, ideally, a Swift Group dealer or Authorised Repairer.

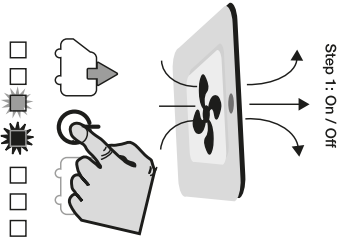
Please be aware a cycle rack can not be fitted onto a model where there is a rear escape window. Please confirm this with your Swift Group Dealer.

Caravan motor movers

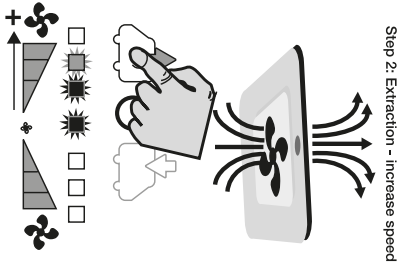
The design and fitment of a caravan motor mover shall be in accordance with the NCC Code of Practice 305 and you should ensure you receive a signed installation certificate of compliance from the installer.

Failure to do so may invalidate your warranty

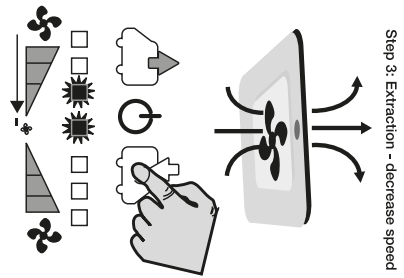
Omni-vent



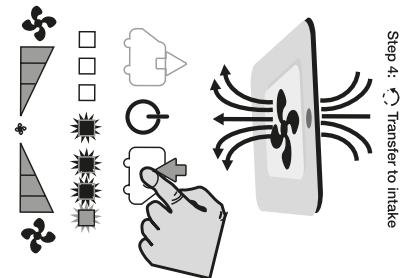
Step 1: On / Off



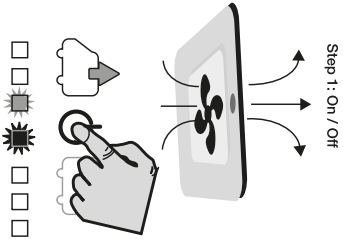
Step 2: Extraction - increase speed



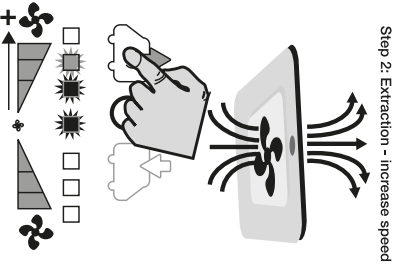
Step 3: Extraction - decrease speed



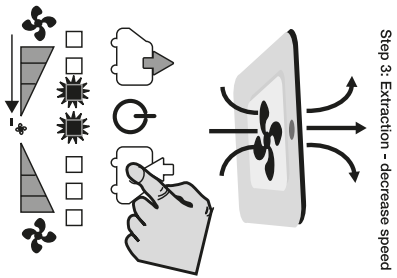
Step 4: Transfer to intake



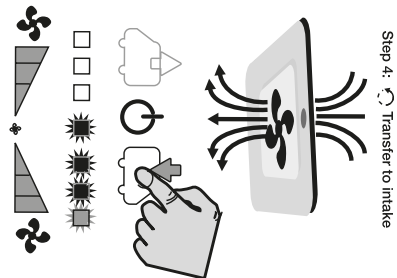
Step 1: On / Off



Step 2: Extraction - increase speed



Step 3: Extraction - decrease speed



Step 4: Transfer to intake

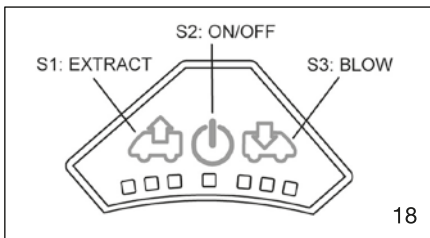
OMNIVENT

Use rooflight

- Close the lid before driving
- To take away the roller blind, unscrew and click the frame off the side of the knob.

Use of the ventilation

- The ventilator is started by the soft switch S2. The middle LED light lights up and the ventilator starts in comfort mode, this is the lowest speed (extract). See fig 18.



- By pushing on the switch S1 (extract) or S3 (intake), the airflow can be adjusted in 6 steps. See table 19.

PUSH BUTTONS	LIGHTS	SPEED	Ampère	Watt
1x (S1)	■ ■ ■ ■ ■ ■ ■ ■	0	0,2 mA	2,4 mW
1x (S1) + 1x (S2)	■ ■ ■ ■ ■ ■ ■ ■	1⬆	0,17 A	2 W
1x (S1) + 2x (S2)	■ ■ ■ ■ ■ ■ ■ ■	2⬆	0,49 A	5 W
1x (S1) + 3x (S2)	■ ■ ■ ■ ■ ■ ■ ■	3⬆	0,90 A	11 W
1x (S1) + 4x (S2)	■ ■ ■ ■ ■ ■ ■ ■	4⬆	1,55 A	20 W
1x (S1) + 5x (S2)	■ ■ ■ ■ ■ ■ ■ ■	5⬆	3,20 A	40 W
1x (S1) + 6x (S2)	■ ■ ■ ■ ■ ■ ■ ■	6⬆	7,20 A	86 W
1x (S1) + 5x (S2) + 1x (S3)	■ ■ ■ ■ ■ ■ ■ ■	5⬆		
1x (S1) + 5x (S2) + 2x (S3)	■ ■ ■ ■ ■ ■ ■ ■	4⬆		
... ..				
1x (S2)	■ ■ ■ ■ ■ ■ ■ ■	0	0,2 mA	2,4 mW

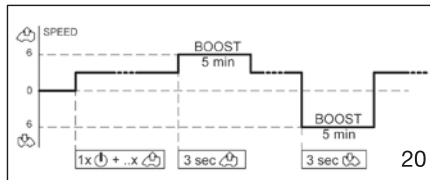
PUSH BUTTONS	LIGHTS	SPEED	Ampère	Watt
1x (S2)	■ ■ ■ ■ ■ ■ ■ ■	0	0,2 mA	2,4 mW
1x (S2) + 1x (S3)	■ ■ ■ ■ ■ ■ ■ ■	1⬆	0,17 A	2 W
1x (S2) + 2x (S3)	■ ■ ■ ■ ■ ■ ■ ■	0	15 mA	0,2 W
1x (S2) + 3x (S3)	■ ■ ■ ■ ■ ■ ■ ■	1⬆	0,17 A	2 W
1x (S2) + 4x (S3)	■ ■ ■ ■ ■ ■ ■ ■	2⬆	0,49 A	5 W
1x (S2) + 5x (S3)	■ ■ ■ ■ ■ ■ ■ ■	3⬆	0,90 A	11 W
1x (S2) + 6x (S3)	■ ■ ■ ■ ■ ■ ■ ■	3⬆	0,90 A	11 W
... ..				

*MIN = 3,7 m³/min (2 W - 0,17 A)

*MAX = 24 m³/min (86 W - 7,20 A)

- In order to save the battery, the speed drops from position 6 to the lowest position after one hour of use.
- It is possible to allow the ventilator to work for 5 minutes on the highest speed (boost). To do this push for 3 seconds on the button

S1 (extraction) or S2 (intake). After 5 minutes the ventilator returns to its previous speed setting. See table in fig 20.



- For reasons of security, the ventilator, the ventilator stops when the tension is too high (19,5 V) or too low (11,1 V) or when the fan is blocked. For trouble shooting see fig 21.

FLASHING LED's	PROBLEM
■ ■ ■ ■ ■ ■ ■ ■	or Tension < 11,1 V or Tension > 19,5V
■ ■ ■ ■ ■ ■ ■ ■	Motor blocked
■ ■ ■ ■ ■ ■ ■ ■	Motor not connected

Maintenance

The ventilator grid can be removed for cleaning. Also the mosquito screen can be taken out for cleaning.

Remark on the transport of the caravan with Omni-vent

The roof light is only waterproof in the direction of the traffic. When transporting the caravan in the opposite direction, or when the back of the caravan is up, ensure the dome is watertight by using the 'Lock-unlock' (not supplied on a ventilator version) or by using something that ensures that the dome remains closed when being transported.

Tourer Rear Vision System

When fitted, a rear vision camera will be present close to the high level brake light at the rear of the caravan, connected to a wireless transmitter housed above the number plate recess.



Fig. 1 Rear camera pod

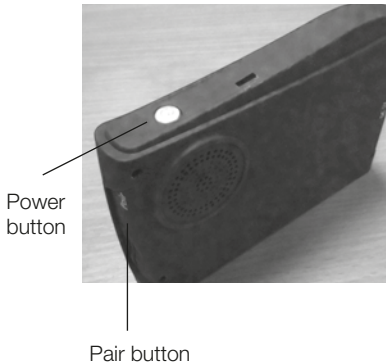


Fig. 2 Rear vision screen

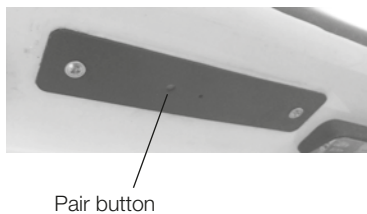


Fig. 3 Rear view transmitter

Supplied separately, a screen with power supply leads, and a windscreen mount, is to be used in the towing vehicle to receive pictures from the transmitter. The screen has an internal re-chargeable battery, allowing short term

use without a power supply lead. For longer journeys, or to re-charge the internal battery, please use the power leads provided.

The camera and transmitter will be operational when the towing vehicle is connected (via the 13-pin towing lead), and the tow vehicle engine is running. When the screen is then turned on, via an extended press of the power button on the top of the unit, images from the camera / transmitter will automatically be displayed. Press and hold the power button again to switch the screen off.

If an image is not displayed, please check the following:

- The screen has two input channels. While the screen is ON, short presses of the power button will alternate the display between these channels. Check the alternate channel for an image.
- The transmitter and receiver need to be paired, to communicate with each other. This should have been done by the supplying dealer, but if the settings have been lost please repeat the procedure described below.

Pairing the transmitter and screen

- Ensure that the screen has sufficient charge for use without a power lead.
- Connect the tow vehicle and start the engine. Ensure you have an assistant with you who can stay in the car while the engine is running, for both safety and security reasons.
- On the screen, find the recessed pairing button as shown in the image on this page. **(Fig. 2)**
- At the rear of the caravan, locate the rectangular plate housed between the number plate lights, and find the pairing button as shown in the image on this page. **(Fig. 3)**
- Turn the screen on. Using a small diameter item such as a paper clip, press the pair button on the screen unit. A message 'PAIRING START' or similar will be displayed. **(Fig. 2)**

TOURER REAR VIEW CAMERA

- Using a small screwdriver, press the pairing button on the rectangular plate between the number plate lights. **(Fig. 3)**
- Once pairing is complete, an image will be displayed on the screen.